



Capital Electric

A Sonepar Company



MID-ATLANTIC

SMARTBUYS

MARCH-APRIL 2021

Big savings on some of your favorite brands from **Capital Electric**



\$8.50 ea.

Kidde 21007581 Firex
Hardwired Smoke Alarm
- Firex I4618 [428802]



More Kidde on pages 59-61

Cooper Lighting Solutions Pages 13-20



COOPER

Lighting Solutions



\$29.95 ea.

NEW!! Cooper
Lighting Solutions
HLA406VWFL9FS1EMWR 4"
LED Directional with Remote
Driver/Junction Box [1469796]



FLUKE®



NEW!! Fluke FLK-IRR1-SOL Solar
Irradiance Meter [1637097]

New products from Fluke on page 71!



KLEIN TOOLS®

For Professionals... Since 1857™



\$69.99 ea.

NEW!! Klein Tools 60146
Safety Helmet, Non-Vented-
Class E, with Rechargeable
Headlamp, White [1590872]

See more Klein Tools on pages 93-94



Not all products available at all locations. Capital Electric is not responsible for misprints or typos. Prices valid March 1 - April 30, 2021 unless otherwise noted. Prices and offers are subject to change or cancellation without notice. Speak to your Capital Electric salesperson for more details. Shop online 24/7 at capitalelectricsupply.com!

The electrical distributor of choice

NEW PRODUCTS!



Hidden Under-Carpet
SKU: XP-UN-096-288Q

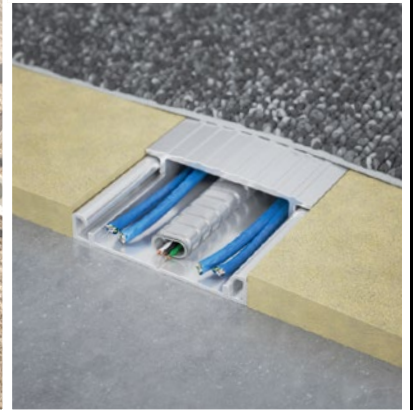

CONNECTRAC[®] EXPRESS WIREWAYS

Pre-wired Power | Quick & Simple Installation | Accommodates Data | Ultra-low Profile System



Smallest Footprint On-Floor
SKU: XP-ON-072-288Q



Contact your Capital sales rep today!

Not all products available at all locations. Please speak to your Capital Electric Sales Representative for more information. Capital Electric is not responsible for misprints or typos. Prices are subject to change without notice.

EXPRESS WIREWAYS



2.7 Under-Carpet Wireway Express Kit

A hidden solution for power & data used in spaces with carpet tiles.

- *Most popular Express Kit*
- *Elegantly disappears under carpet tiles*
- *Most forgiving install*
- *Don't have to cut carpet*

SKU	DESCRIPTION	INCLUDES	TECH INFO
XP-UN-096-288Q	8' Wireway with quad receptacle	24' pre-wired power infeed, top cap, bottom track, ABS plastic and MDF ramps, wall base trim	<ul style="list-style-type: none"> • Holds (0-4) Data Cables • 1000 lb load test



2.7 On-Floor Wireway Express Kit

Installs on top of any flooring to supply power & data where it's needed.

- *Smallest footprint on-floor*
- *Quickest install*
- *Durable anodized aluminum finish*

Optional 6' Wireway Extension

Allows on-floor system to extend up to 12' length.

- *Cutable in field for exact sizing*

SKU	DESCRIPTION	INCLUDES	TECH INFO
XP-ON-072-288Q	6' Wireway with quad receptacle	24' pre-wired power infeed, top cap, bottom track, end component, wall base trim	<ul style="list-style-type: none"> • Holds (0-4) Data Cables • 1000 lb load test
ON-2.7-072-AL	6' Wireway Extension	Top cap and bottom track (uses wall base trim and end component from original kit)	



07072020

CONNECTRAC®



capitalelectricsupply.com

LumiCleanse™ UVC1 ULTRAVIOLET GERMICIDAL FIXTURE

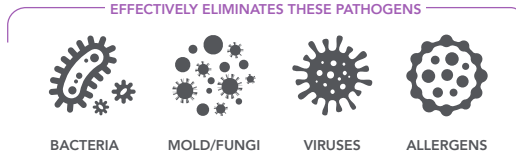

effectively kills surface & airborne pathogens

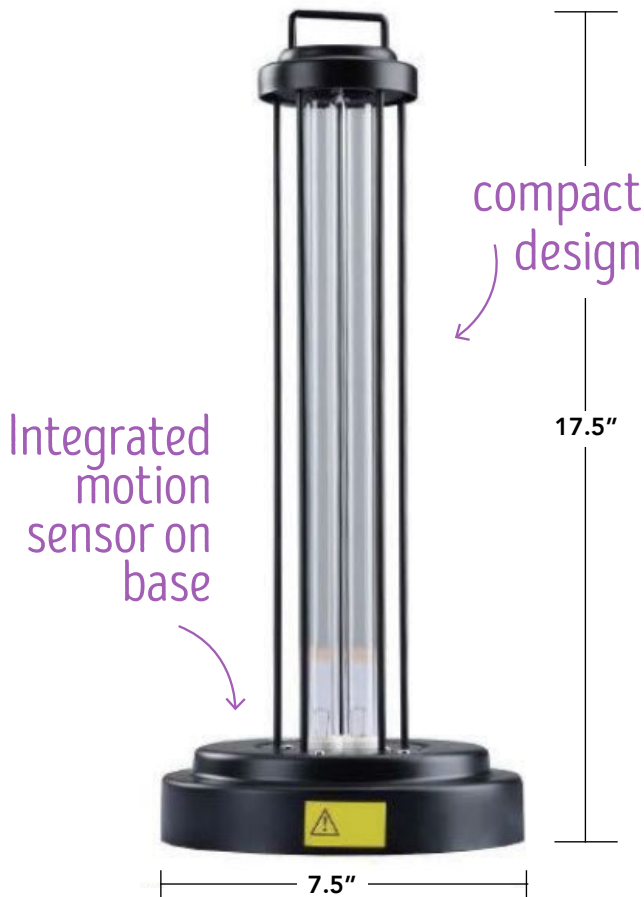

- Germicidal UV-C Quartz Lamps with 254nm wavelength has a proven track record for use in germicidal applications.
- Designed with safety in mind. Once the unit is turned on by the remote control, there is a 15 second delay before the UV-C light starts, to give the user time to exit the space. There is also an integrated motion sensor. If people accidentally walk into the space while the light is operating – the fixture will automatically shut off.
- Perfect for placement on tables, work benches or pendant hung from ceiling.
- Low power consumption – uses only 38W.
- Recommended coverage area is 100 sq ft.
- ETL Listed. One of the first products in the world of this type to be tested & certified to UL safety requirements.

PART #	UPC	WATTAGE
RP-UVC-LC1-38W	844006058395	38W



05.12.20 Information is subject to change without notice.



BOLLARD RETROFITS 360° OMNI DIRECTIONAL DESIGN

Light Efficient Design

120-277V VOLTAGE* E26 / EX39 MEDIUM + MOGUL BASES ULTYPE B BALLAST BYPASS INSTALL METHOD -40°F TO 122°F OPERATING TEMP UP BASE DOWN MOUNTING SIDEWAYS 6kA SURGE PROTECTION 80+ CRI L70 50,000 RATED LIFE 5 YEAR WARRANTY

three color temps in one

flexCOLOR



change color temperatures with the click of a switch

- Default setting is 4000K but can be changed to 3000K or 5000K with a flip of a switch.
- Available in 11W, 14W, 18W & 24W models replacing up to 150W HID.
- FlexColor allows for a reduction of skus needed to be stocked.
- Multi-directional mounting capability & 360° design. Use base down, base up or base sideways without affecting performance.
- Pretested & potted drivers are burnt in 3x prior to shipping and protected against vibration & moisture.
- Expertly engineered to work efficiently in enclosed fixtures & damp environments, while also protected against insects & dust.
- Dual stage MOV protection with integrated 6kA surge.



Light Efficient Design LED-8037E345-A 11W Flex Color Bollard Lamp Replacement Lamp Med Base [1606195]



Light Efficient Design LED-8038E345-A 14W Flex Color Bollard Lamp Replacement Lamp Med Base [1606196]



Light Efficient Design LED-8039E345-A 18W Flex Color Bollard Lamp Replacement Lamp Med Base [1606197]



Light Efficient Design LED-8039M345-A 18W Flex Color Bollard Lamp Replacement Lamp Mogul Base [1606198]



Light Efficient Design LED-8029E345-A 24W Flex Color Bollard Lamp Replacement Lamp Med Base [1606199]



Light Efficient Design LED-8029M345-A 24W Flex Color Bollard Lamp Replacement Lamp Mogul Base [1606200]

Not all products available at all locations. Please speak to your Capital Electric Sales Representative for more information. Capital Electric is not responsible for misprints or typos. Prices are subject to change without notice.

QTE LED

Flood Light

\$41.95 ea.



1331170

Lithonia Lighting QTE-LED-P1-120-THK-DDB-M6 24W LED Flood 2500 Lumens 4000K Bronze [1331170]

\$41.95 ea.



1331171

Lithonia Lighting QTE-LED-P1-120-THK-WH-M6 24W LED Flood 2500 Lumens 4000K White [1331171]

\$56.50 ea.



1331172

Lithonia Lighting QTE-LED-P2-40K-120-THK-DDB-M6 40W LED Flood 4000 Lumens 4000K Knuckle Fitter [1331172]

\$56.50 ea.



1331174

Lithonia Lighting QTE-LED-P2-40K-120-YK-DDB-M6 40W LED Flood 4000 Lumens 4000K Yoke Mount [1331174]

\$69.95 ea.



1331175

Lithonia Lighting QTE-LED-P3-40K-120-THK-DDB-M6 66W LED Flood 6750 LUMENS 4000K Knuckle Fitter [1331175]

\$69.95 ea.



1331176

Lithonia Lighting QTE-LED-P3-40K-120-YK-DDB-M6 66W LED Flood 6750 LUMENS 4000K Yoke Mount [1331176]



Quick Facts:

- Replaces up to 500W Quartz Halogens
- DLC Listed!
- Available in two colors - Textured Bronze and White
- 4000K and 5000K CCT options
- 5 Year warranty

Outdoor



NEW PRODUCTS!



WPX LED

Wall Pack Luminaires

\$114.95 ea.  1596323
NEW!! Lithonia Lighting WPX1-LED-P2-50K-MVOLT-DDBXD-M4 24W LED Wall Pack 2900 Lumens 4000K 120/277V [1596323]

\$147.95 ea.  1596325
NEW!! Lithonia Lighting WPX2-LED-40K-MVOLT-DDBXD-M2 47W LED Wall Pack 6000 Lumens 4000K 120/277V [1596325]

\$199.95 ea.  1605749
NEW!! Lithonia Lighting WPX3-LED40K-MVOLT-DDBXD 69W LED Wall Pack 9200 Lumens 4000K 120/277V [1605749]



Quick Facts:

- Three sizes deliver 1,550 to 9,200 lumens
- Replace up to 400W metal halide
- Photocell and battery pack options
- Available in 3000K, 4000K and 5000K
- DLC listed
- 5-year limited warranty

SMARTBUYS

Pricing valid March 1 - April 30, 2021



Commercial Outdoor

Not all products available at all locations. Please speak to your Capital Electric Sales Representative for more information. Capital Electric is not responsible for misprints or typos. Prices are subject to change without notice.

NEW PRODUCTS!



CSS LED

Contractor Single Strip Light

The Easiest Strip to Order, Stock, and Install

CSS is the Lithonia Lighting® go-to Contractor Select™ Strip. It is built on the existing CDS framework with a beautiful diffuse single lens.

Ordering Made Easy

This is the perfect strip to order for almost any basic application. From residential workspace to commercial warehouse, the CSS features 4- and 8-foot configurations with up to 10,000 lumens, all DLC listed - providing versatility for many applications.

Stock 9 SKUs in 1

With the ability to switch lumens and adjust color temperature in one fixture, CSS can be adapted to the needs of each project – 9 different variations within the same SKU!

Installation Options

The CSS can be surface mounted, suspended or row mounted. Additionally, can be opened without any tools. The quick disconnects between the driver and the LEDs allow you to remove the LED tray so it doesn't interfere with installation.



Quick Facts:

- Single lensed version of our popular CDS Strip
- 4' and 8' lengths offering from 3,000-10,000 lumens
- Available Switchable White and Adjustable Light Output technology
- L70 at 80,000 hours
- Diffuse acrylic lens
- Standard 0-10V dimming
- ANSI Standard of 2.5kV surge protection
- Optional motion sensor

\$64.95 ea. 

NEW!! Lithonia Lighting CSS-L48-AL03-MVOLT-SWW3-80CRII [1533103]

\$115.50 ea. 

NEW!! Lithonia Lighting CSS-L96-AL04-MVOLT-SWW3-80CRI [1533106]

CS
CONTRACTOR
SELECT™



SMARTBUYS

Pricing valid March 1 - April 30, 2021



Contractor Select™

TFX LED

Floodlights

The TFX LED floodlights from Lithonia Lighting deliver the best value in lighting, from a brand you can trust. Superior performance and robust design make this product suitable for any general purpose floodlighting application.

FEATURES:

- Ideal solution to replace up to 400W metal halide floodlights
- Floodlight pays for itself in less than 2 years
- Robust design and cost effective – ideal for outdoor installations



\$169.95 ea.

NEW!! Lithonia Lighting TFX1-LED-40K-MVOLT-YK-DDBXD-M6 54W LED Flood 7200 Lumens 4000K Knuckle Mount Bronze [1456181]



\$288.95 ea.

NEW!! Lithonia Lighting TFX2-LED-40K-MVOLT-YK-DDBXD 94W LED Flood 12,000 Lumens 4000K Yoke Mount Bronze [1456183]



\$433.95 ea.

NEW!! Lithonia Lighting TFX3-LED-40K-MVOLT-YK-DDBXD 188W LED Flood 25,000 Lumens 4000K Yoke Mount Bronze [1456184]

NEW PRODUCTS!



\$93.50 ea.

NEW!! Lithonia TWR1-LED-ALO-40K-MVOLT-DDBTXD-M2 Wall Pack [1399575]

Adjustable light output 1,100 - 6,200 Lumens.

\$175.50 ea.

NEW!! Lithonia TWR2-LED-ALO-40K-MVOLT-DDBTXD-M2 Wall Pack [1475285]

Adjustable light output 3,050 to 11,800 Lumens.

Adjustable Light Output Feature allows the contractor to adjust light input during installation.

FEATURES & SPECIFICATIONS

INTENDED USE — Ideal one-for-one replacement of conventional lighting systems such as HID and fluorescent. For use in light Industrial applications such as, warehousing and other large indoor spaces with mounting heights ranging from 10' – permitted. **Certain airborne contaminants can diminish integrity of acrylic and LED's.** [Click here for Acrylic Environmental Compatibility table for suitable uses.](#)

Certain airborne contaminants may adversely affect the functioning of LEDs and other electronic components, depending on various factors such as concentrations of the contaminants, ventilation, and temperature at the end-user location. [Click here for a list of substances that may not be suitable for interaction with LEDs and other electronic components.](#)

CONSTRUCTION — Extruded aluminum channels enable superior thermal performance. Glare Control acrylic lens diffuses light source and reduces glare while protecting LEDs. Lens meets DLC 5.1 standards for UGR (Unified Glare Rating).

ELECTRICAL — 70% lumen maintenance at > 100,000 hours. Thermally protected driver standard with 0-10V dimming. Luminaire surge protection level: designed to withstand up to 6kV/3kA per ANSI C82.77-5-2015 Multi-volt driver, 120-277V standard.

INSTALLATION — Compact Pro™ package includes V-hanger hardware kit with 2- V-hanger brackets and 2-36" chain lengths. Fixture is suitable for mounting by chain, cable, surface-mount bracket, or hook monopoint. Designed for use in ambient temperatures ranging from -40°C to 55°C when suspended 18" off ceiling. Surface mount to 45°C ambient operation.

LISTINGS — CSA listed. Damp location listed.

DesignLights Consortium™ (DLC) Premium qualified product. Not all versions of this product may be DLC Premium qualified. Please check the DLC Qualified Products List at www.designlights.org/QPL to confirm which versions are qualified.

WARRANTY — 5-year limited warranty. Complete warranty terms located at: www.acuitybrands.com/support/warranty/terms-and-conditions

Note: Actual performance may differ as a result of end-user environment and application. All values are design or typical values, measured under laboratory conditions at 25°C. Specifications subject to change without notice.

LED High Bay

COMPACT PRO™

12,000 through 30,000 Lumens

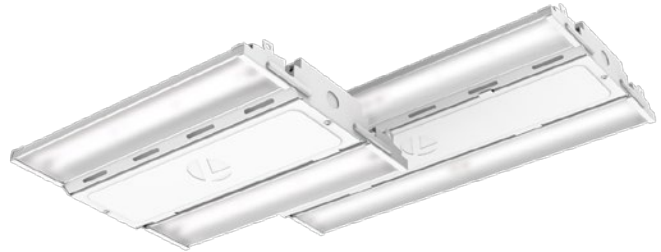

\$79.95 ea.

NEW!! Lithonia CPHB-12LM-MVOLT-40K 12,000 LUMEN
LED HIGH BAY 120/277V [1632901]

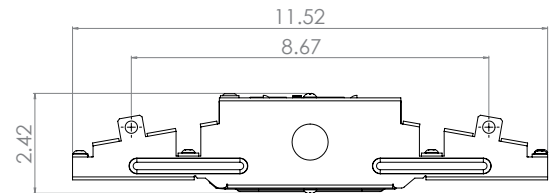
End View: CPHB 12LM, 15LM, 18LM, 24LM, 30LM

\$106.95 ea.

NEW!! Lithonia CPHB-18LM-MVOLT-40K 18,000 LUMEN
LED HIGH BAY 120/277V [1632905]

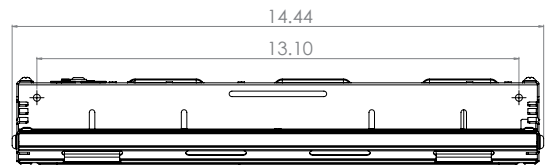
Side View: 12000LM, 15000LM, 18000LM MVOLT

\$126.95 ea.

NEW!! Lithonia CPHB-24LM-MVOLT-40K 24,000 LUMEN
LED HIGH BAY 120/277V [1632907]

\$166.95 ea.

NEW!! Lithonia CPHB-30LM-MVOLT-40K 30,000 LUMEN
LED HIGH BAY 120/277V [1632909]



NEW PRODUCTS!

Contractor Select™
MNSL
LED

The basic, non-dimming, damp location MNSL strip lights mount individually or in continuous rows to the ceiling or wall, both horizontally or vertically.

FEATURES:

- Diffuse polycarbonate lens providing a single smooth line of light shaped to resemble a fluorescent tube
- Quick and simple to install with the snap-lock tool-less channel cover
- Ideal choice for commercial task lighting, restrooms, under/over cabinet, storage closets and displays

*Prolonged use at 55°C, may impact long-term performance
‡ These configurations are ENERGY STAR® Certified.



\$41.95 ea.

NEW!! Lithonia MNSL-L48-2LL-MVOLT-40K-80CRI 4FT
DOUBLE LENS LED STRIPLIGHT 120/277V [1485564]

\$85.95 ea.

NEW!! Lithonia MNSL-L96-2LL-MVOLT-40K-80CRI 8FT
DOUBLE LENS LED STRIP LIGHT 120/277V [1498118]

SMARTBUYS

Pricing valid March 1 - April 30, 2021



Channel Nuts

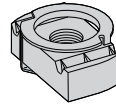

Twirl-Nut™

Part No.	Thread Size	Fits Channel Sizes	Nut Thickness		Wt./C		
			In.	mm	Lbs.	kg	
TN221	#8-32	All sizes except B62 & B72	1/4"	(6.3)	7.0	(3.17)	
TN227	#10-32	All sizes except B62 & B72	1/4"	(6.3)	7.0	(3.17)	
TN222	#10-24	All sizes except B62 & B72	1/4"	(6.3)	7.0	(3.17)	
TN224	1/4-20	All sizes except B62 & B72	1/4"	(6.3)	6.7	(3.04)	
TN223	5/16-18	All sizes except B62 & B72	1/4"	(6.3)	6.7	(3.04)	
TN228	3/8-16	All sizes except B62 & B72	3/8"	(9.5)	9.3	(4.22)	
TN226	7/16-14	All sizes except B62 & B72	3/8"	(9.5)	8.8	(3.99)	
TN225	1/2-13	B11, B12, B22, B24, B26, B32	1/2"	(12.7)	11.6	(5.26)	
TN525	1/2-13	B42, B52, B54, B56	3/8"	(9.5)	8.8	(3.99)	
TN255	5/8-11	B11, B12, B22, B24, B26, B32	1/2"	(12.7)	11.0	(4.99)	
Metric Threads	BMT-6	M6 x 1	All sizes except B62 & B72	1/4"	(6.3)	6.9	(3.13)
	BMT-8	M8 x 1.25	All sizes except B62 & B72	1/4"	(6.3)	6.7	(3.04)
	BMT-10	M10 x 1.5	All sizes except B62 & B72	3/8"	(9.5)	9.6	(4.35)
	BMT-12	M12 x 1.75	All sizes except B62 & B72	3/8"	(9.5)	9.2	(4.17)
	BMT-D-12	M12 x 1.75	B11, B12, B22, B24, B26, B32	1/2"	(12.7)	12.2	(5.53)



Eaton B-LINE TN224-ZN-1/4 1/4" Twirl-Nut Channel Nut [8980]



Eaton B-LINE TN228-ZN-38 3/8" Twirl-Nut Channel Nut [23119]

SMARTBUYS

Pricing valid March 1 - April 30, 2021



Powering Business Worldwide



Fail-Safe

GAW Germicidal Air Wall Mount

- Able to be used in occupied spaces
- Designed to use the latest in Germicidal UV source technology
- Compact 2ft length
- Large area of coverage
- Horizontal distribution keeps GUV in upper air
- UL 1598 Listed
- Minimum Ceiling Height of 9'
- Minimum Mounting Height 8'3" to bottom of the fixtures
- Professional layouts can be completed by Cooper Lighting Solutions upon request



Fail-Safe

GAC Germicidal Air Ceiling Mount

- Able to be used in occupied spaces
- Designed to use the latest in Germicidal UV source technology
- Compact 2ft length
- Large area of coverage
- Horizontal distribution keeps GUV in upper air
- UL 1598 Listed
- Minimum ceiling height of 9'
- Minimum recommended spacing is 12' on center and 6' from nearest wall
- Professional layouts can be completed by Cooper Lighting Solutions upon request

Pure protection against bacteria and viruses using the power of light



Trusted

35 years experience in UV-C disinfection and strong application expertise.



Effective

Proven effectiveness against bacteria, mold, mildew, and viruses.



Continuous

Can be used in occupied spaces.



Versatile

Can be used in numerous applications.



NEW PRODUCTS!



Save money Save time Peace of mind

The CGT Panel LED series is the contractor go-to panel providing customers an affordable panel that fits in shallow plenums with room to spare. Acrylic micro optics provide uniform illumination from corner to corner. It's back-lit, durable design provides immediate opportunities to replace fluorescent fixtures with a LED solution. CGT is an excellent lighting solution for commercial office spaces, schools, healthcare and retail merchandising areas.

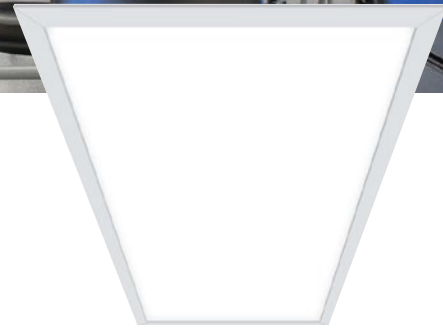

\$42.95 ea.



NEW!! Cooper Lighting Solutions
24CGT4535C [1545925]



NEW!! Cooper Lighting Solutions
24CGT4540C [1525013]



NEW!! Cooper Lighting Solutions
24CGT4550C [1545926]

\$27.95 ea.



NEW!! Cooper Lighting Solutions
22CGT3535C [1545927]



NEW!! Cooper Lighting Solutions
22CGT3540C [1536909]



NEW!! Cooper Lighting Solutions
22CGT3550C [1545928]

NEW PRODUCTS!



\$29.95 ea.



NEW!! Cooper Lighting Solutions HLA406VWFL9FS1EMWR 4" LED Directional with Remote Driver/Junction Box

[1469796]

- Can ess, recessed lighting without requiring a housing or j-box
- Airtite, wet rated, can be used in shower and outdoor light applications
- Wide beam angle, 80°
- Housing and j-box not required; easy to install - spring clips firmly secure fixture in ceiling
- Repositionable driver junction box



HALO

HLBSL

LED Lens Downlight with Remote Driver / Junction Box

Typical Applications

Residential

HLB SL4 Series 6 Inch

\$14.95 ea.



NEW!! Cooper Lighting Solutions HLBSL6-09-9FS23-1E-MW-R, 2700K/3000K/3500K [1545919]

\$14.95 ea.



NEW!! Cooper Lighting Solutions HLBSL6-09-9FS35-1E-MW-R, 3000K/4000K/5000K [1545921]

HLB SL4 Series 4 Inch

\$13.95 ea.



NEW!! Cooper Lighting Solutions HLBSL4-06-9FS23-1E-MW-R, 2700K/3000K/3500K [1545922]

\$13.95 ea.



NEW!! Cooper Lighting Solutions HLBSL4-06-9FS35-1E-MW-R, 3000K/4000K/5000K [1545923]

Top Product Features

- Direct mount - does not require recessed housing or junction box
- Delivers up to 1,049 lumens
- Achieves L70 at 35,000 hours in IC and non-IC applications
- 3 temperature CCT selectable. 2700K/3000K/3500K and 3000K/4000K/5000K models



SMARTBUYS

Pricing valid March 1 - April 30, 2021



Not all products available at all locations. Please speak to your Capital Electric Sales Representative for more information. Capital Electric is not responsible for misprints or typos. Prices are subject to change without notice.



Lumark

LAS

Area / Site Luminaire

Typical Applications

Outdoor • Parking Lots • Walkways • Building Areas

Interactive Menu

- Stock Ordering Information [page 2](#)
- Ordering Information [page 2](#)
- Product Specifications [page 2](#)
- Mounting Details [page 2](#)
- Energy and Performance Data [page 2](#)
- Controls Options [page 3](#)

Quick Facts

- 10-position lumen selectable across 2 housing sizes
- Lumen packages range from 4,900 - 34,000 lumens (30W - 250W)
- Replaces up to 450W and 1,000W HID equivalent
- Efficacies up to 135 lumens per watt at maximum output
- Energy and maintenance savings up to 79% versus HID solutions

Product Certifications



Product Features



\$199.95 ea.

NEW!! Cooper Lighting Solutions LAS45S-T4 152W LED AREA LIGHT W/SLIPFITTER 120/277V [1633220]

\$319.95 ea.

NEW!! Cooper Lighting Solutions LAS100S-T4 250W LED AREA LIGHT WITH SLIPFITTER 120/277V [1635609]

Square Polycarbonate CCT Motion Floodlight Series



MST18VC Series



MST28VC Series

NEW PRODUCTS!



Catalog Number	Non-LED Equivalent	Head Count	Lumens	Watts	Voltage	Mounting	Controls	UPC
MST18VCB	90W Inc.	2	1,346	13	120V	Wall / Eave	M (180°)	080083837236
MST18VCW	90W Inc.	2	1,346	13	120V	Wall / Eave	M (180°)	080083837250
MST28VCB	180W Inc.	2	2,200	20	120V	Wall / Eave	M (180°)	080083837274
MST28VCW	180W Inc.	2	2,200	20	120V	Wall / Eave	M (180°)	080083837298

\$46.95 ea.



NEW!! Cooper Lighting Solutions MST18VCB Twin Motion LED Flood Light 1100LM Bronze [1480045]

\$58.95 ea.



NEW!! Cooper Lighting Solutions MST28VCB Twin Motion LED Flood Light 2000LM Bronze [1480047]

\$46.95 ea.



NEW!! Cooper Lighting Solutions MST18VCW Twin Motion LED Flood Light 1100LM White [1480046]

\$58.95 ea.



NEW!! Cooper Lighting Solutions MST28VCW Twin Motion LED Flood Light 2000LM White [1480048]



Save money Save time Peace of mind



The Metalux FM is an Energy Star LED flushmount that comes with a field selectable CCT switch. The FM with selectable CCT provides light color options (from warm to bright white) to suit any decor and space. Typical surface mount applications include bedrooms, closets, corridors, stairways, and utility rooms.

\$28.95 ea.



NEW!! Cooper Lighting Solutions FM11WRCCR 11" LED Flush Mount Color Tuneable [1520154]

\$37.95 ea.



NEW!! Cooper Lighting Solutions FM15WRCCR 15" Round LED Flush Mount Color Tuneable [1520155]



Not all products available at all locations. Please speak to your Capital Electric Sales Representative for more information. Capital Electric is not responsible for misprints or typos. Prices are subject to change without notice.

NEW PRODUCTS!



\$53.95 ea.  1605823

NEW!! Cooper Lighting Solutions SMD12R209SWHE
12" Round Surface Mount Fixture 2000 Lumen
120v/277v CCT Selectable 0-10V dimming [1605823]

HLB8

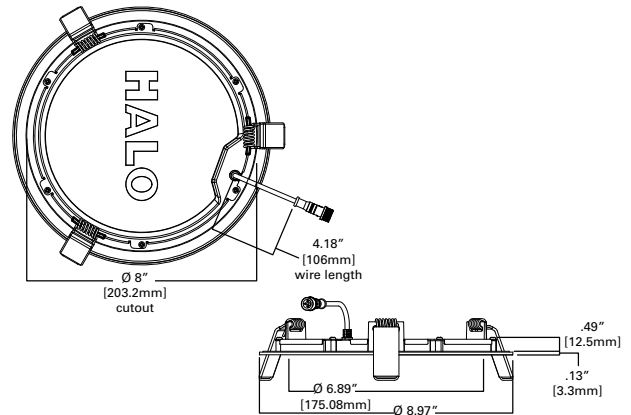

\$33.95 ea.  1605824

NEW!! Cooper Lighting Solutions HLB8169FS1EMWR 8"
Round Wafer LED Trim 120v CCT Selectable 1600 Lumens,
Phase Cut Dimming [1605824]

\$53.95 ea.  1605825

NEW!! Cooper Lighting Solutions HLB8LS9FSE010MWR 8"
Round Wafer LED Trim 120/277v CCT Selectable Lumen
Selectable (1400-1900-2400) 0-10V dimming [1605825]



2700K • 3000K • 3500K
4000K • 5000K



**Cooper Lighting Solutions RA6069S1EWHDMR 6" Adjustable
Gimbal Direct Mount LED Trim CCT Selectable [1575216]**



**Cooper Lighting Solutions RA4069S1EWHDMR 4" Adjustable
Gimbal Direct Mount LED Trim CCT Selectable [1575217]**



**Cooper Lighting Solutions XTOR2B 18W LED WALL
PACK 5000K 120/277V** [1175559]



**Cooper Lighting Solutions XTOR3B 26w LED WALL
PACK 5000K 120/277V** [1181900]



**Cooper Lighting Solutions XTOR4B 38W LED WALL
PACK 5000K 120/277V** [1175561]



**Cooper Lighting Solutions XTOR6B 58W LED WALL
PACK 5000K 120/277V** [1180986]



**Cooper Lighting Solutions XTOR8B 81W LED WALL
PACK 5000K 120/277V** [1168712]



- Patented, slim, low-profile LED design
- Wall, surface, post, bollard, low-level, inverted, floodlight mounting
- Die-cast aluminum, hinged, removable door and back box
- 18W, 26W, 38W, 58W, 81W models
- Secure lock-hinge and single-point closure
- Mounts to a variety of junction boxes or conduit entries
- Silicone-sealed optical LED lens, Available in 5000K or 4000K (CCT)
- 120V, 120-277V and 347V models available
- Optional floodlighting kit converts from wall to floodlight

SMARTBUYS

Pricing valid March 1 - April 30, 2021





\$7.95 ea.  1516690
Cooper Lighting Solutions LT460WH6930R 4" LED Recessed Baffle Trim 3000K 120V [1516690]

\$7.95 ea.  1510796
Cooper Lighting Solutions LT560WH6930R 6" LED Recessed Baffle Trim 3000K 120V [1510796]

- LED retrofit shallow lens downlight with baffle trim
- Retrofits existing housings with screwbase adapter included
- For use with HALO and other new construction and remodel housings
- 5 color temperatures: 2700K, 3000K, 3500K, 4000K, 5000K CCT; CRI: 90
- Dead Front, non-conductive construction; L70 at 35,000 hours
- Friction springs holds trim securely to ceiling
- 120V; Phase dimming down to 10%; Lumens: up to 665; Up to 76 lm/W
- Damp and wet location listed for showers and protected ceilings
- Meets NFPA requirements for use in closets; AIR-TITE™
- ENERGY STAR™ certified; 5-year warranty



 1587797
Cooper Lighting Solutions HLC9129401EWH 9" Closet Light LED 4000K [1587797]



 1587798
Cooper Lighting Solutions HLCMS9129401EWH 9" Closet Light LED 4000K w/ Motion Sensor [1587798]

SMARTBUYS
 Pricing valid March 1 - April 30, 2021





FOLLOW US

A stylized green hand with the index finger pointing to the right, positioned below the word 'FOLLOW' and pointing towards the word 'US'.

FACEBOOK

@CapitalElecSply



LINKEDIN

Capital Electric



TWITTER

@CapitalElecSply



INSTAGRAM

@capitalelecsply

WE ARE SOCIAL

NEW PRODUCTS!



Wattage Comparison

	Traditional Source	Traditional System Wattage	LED System Wattage	Energy Savings
Type A	F032T8 2XISN QHE	55	30.8	28.2W/48%
Type B	F032T8 2XISN QHE	55	24.6	32.6W/55%

Ambient Operating Range

— -4°F to +113°F (-20°C to +45°C)

Certifications and Listings

- cULus 1993
- cULus 1598c
- RoHS
- Lead Free
- NSF
- FCC
- DLC Standard



\$8.75 ea.

NEW!! Sylvania LED12T8/L48/FG/835/AB (40588) 4FT LED DUAL ESSENT LED T8 LAMP 3500K [1482476]



\$8.75 ea.

NEW!! Sylvania LED12T8/L48/FG/841/AB (40589) 4FT LED DUAL ESSENT LED T8 LAMP 4100K [1479418]



\$8.75 ea.

NEW!! Sylvania LED12T8/L48/FG/850/AB (40590) 4FT LED DUAL ESSENT LED T8 LAMP 5000K [1482478]

SYLVANIA



ECO LED T8 Type B Ballast Free



\$3.99 ea.

Sylvania ECOLED18T8L48FG841TYPEB (40970) 4FT LED T8 LED LAMP BALLAST FREE ECO 4000K [1603892]

\$3.99 ea.

Sylvania ECOLED18T8L48FG850TYPEB (40971) 4FT LED T8 LED LAMP BALLAST FREE ECO 5000K [1603893]

ECO LED T8 Type A



\$3.99 ea.

NEW!! Sylvania ECOLED16T8L48FG835TYPEA 4FT LED T8 ECO LED LAMP 3500K [1603887]

\$3.99 ea.

NEW!! Sylvania ECOLED16T8L48FG841TYPEA 4FT LED T8 ECO LED LAMP 4000K [1603888]

SYLVANIA Lamps

LEDlescent™ LED T5HO Lamps

Internal Driver/Line Voltage Linear LED T5HO lamps

Application

LEDlescent T5HO Ballast-Free lamps are an energy saving alternative, designed to replace traditional fluorescent T5HO lamps by bypassing the existing ballast to operate directly on 120-277V.

Benefits and Features

- Double ended platform where lamp is wired end-to-end preventing non passive failure of a fluorescent lamp should it be inadvertently installed in the fixture
- Patented built-in safety circuit prevents current from flowing through the lamp when only one end is engaged in the socket thereby eliminating potential shock hazard
- No risk of electrical arcing between the lamp pins and the lamp holders
- LPW: Up to 145W
- CCT: 3000K, 3500K, 4100K, 5000K
- Non-dimmable
- CRI: 82
- Beam angle: 180°

Electrical

- Installed directly on 120-277V; no ballast required
- Power factor >0.90, THD ≤20%

Rated Life

- 50,000 hours (L₇₀)

Warranty

- 5 year limited lamp warranty (24/7 operation)

Ambient Operating Range

- -4°F to 113°F (-20°C to 45°C)

Max Case Temperature

- 140°F (60°C)

NEW PRODUCTS!



Wattage Comparison

Traditional Source	Traditional System Wattage	LED System Wattage	Energy Savings
54W T5HO Fluorescent with QHE2x54PSN	119W	48W	60%

Certifications and Listings

- cULus 1598C
- RoHS
- Lead Free
- Mercury Free
- NSF
- FCC*
- DLC

*FCC Title 47 CFR, Part 15 Subpart B Class B

Installation

Please refer to the Installation manual included inside the packaging and the application information listed below for more information.



NEW!! Sylvania LED24T5HO/L48/FG/841/BF (40610)
4FT LED T5 HO BALLAST BYPASS LAMP 4000K [1563906]



NEW!! Sylvania LED24T5HO/L48/FG/850/BF (40611)
4FT LED T5 HO BALLAST BYPASS LAMP 5000K [1563907]



LED528 5-20



SubstiTUBE® CURVALUME® IPS LED T8

Compatible LED T8 for use with instant start and select programmed rapid start (parallel wiring) electronic T8 ballasts



SYLVANIA SubstiTUBE CURVALUME IPS LED T8 lamps are an energy saving alternative, designed to replace traditional fluorescent T8 lamps. These shatter-resistant LED T8 lamps contain no mercury, provide instant light and a uniform light distribution.

Engineered to operate on existing instant start and select programmed rapid start electronic T8 ballasts, these lamps minimize labor and recycling costs. Because the SubstiTUBE CURVALUME IPS LED T8 is not affected by switching cycles, the use of occupancy or vacancy sensors can be installed with the existing instant start ballasts for optimal energy savings.

Install a new QHE Instant start ballast with the SubstiTUBE CURVALUME IPS LED T8 lamp for optimal performance and to take advantage of the QUICK 72SUB+ System warranty. (See website for details.)



\$12.95 ea.
Sylvania LED15T8/U/
FP/835/BF/40613 6IN T8
LED U-Bend Ballast Free
Lamp 3500K [1473701]



\$12.95 ea.
Sylvania LED15T8/U/
FP/841/BF/40614 6IN T8
LED U-Bend Ballast Free
Lamp 3500K [1473698]

SMARTBUYS

Pricing valid March 1 - April 30, 2021



\$7.80 ea.
Sylvania LED/RT5/6/725/930/G2/RP2 (40629) 6"
LED Recess Trim 3000K [1512802]



\$7.80 ea.
Sylvania LED/RT4/675/930/G2/RP2 (40625) 4"
LED Recess Trim 3000K [1512312]

SYLVANIA





SMARTBUYS

Pricing valid March 1 - April 30, 2021

ULTRA LED™ High Lumen Lamps



Application

ULTRA LED HID replacement lamps are ideal for indoor high/low bay lighting and outdoor decorative post top fixtures in walkway lighting applications.

Benefits and Features

- Lasts up to 5 times longer than HID lamps
- No warm-up time, instant on with full light output and stable color
- Consumes up to 76% less energy than equivalent HID lamps while delivering same light output
- Rated for open and enclosed fixtures
- Replacement for 70W-400W HID medium/mogul base applications
- Up to 145 LPW
- 3000K, 4000K and 5000K color temperatures
- CRI 80+
- 360° beam angle (or omnidirectional) with Type V distribution

Electrical

- 120-277VAC
- Power Factor 98%
- 6kV surge protection

Rated Life

- 50,000 hours (L₇₀)



Wattage Comparison

Traditional Source	Traditional System Wattage	LED System Wattage	Energy Savings	Energy Savings Over Lamp Life*
HID Metal Halide	70W	18W	74%	\$286
HID Metal Halide	100W	27W	73%	\$402
HID Metal Halide	150W	36W	76%	\$627
HID Metal Halide	150W	45W	70%	\$577
HID Metal Halide	175W	54W	69%	\$666
HID Metal Halide	250W	80W	68%	\$935
HID Metal Halide	320W	100W	69%	\$1,210
HID Metal Halide	400W	120W	70%	\$1,540

*Energy savings over life of lamp calculated at \$0.11/kWh

\$21.95 ea.



NEW!! Sylvania LED18HIDR840 LED HID Replacement, 18 Watt, 2600 Lumen, 4000K, 120-277V [1554974]

\$26.95 ea.



NEW!! Sylvania LED27HIDR840-4/CS-1/SKU LED HID Replacement, 27 Watt, 3900 Lumen, 4000K, 120-277V [1536089]

\$39.95 ea.



NEW!! Sylvania LED36HIDR840-4/CS-1/SKU LED HID Replacement, 36 Watt, 5200 Lumen, 4000K, 120-277V [1557308]

\$48.75 ea.



NEW!! Sylvania LED54HIDR840 LED HID Replacement, 54 Watt, 7800 Lumen, 4000K, 120-277V [1548260]

\$73.50 ea.



NEW!! Sylvania LED80HIDR840-4/CS-1/SKU LED HID Replacement, 80 Watt, 11600 Lumen, 4000K, 120-277V [1548261]

\$84.95 ea.



NEW!! Sylvania LED100HIDR840 LED HID Replacement, 100 Watt, 14500 Lumen, 4000K, 120-277V [1568722]

\$89.95 ea.



NEW!! Sylvania LED120HIDR840-4/CS-1/SKU LED HID Replacement, 120 Watt, 17400 Lumen, 4000K, 120-277V [1568721]

NEW PRODUCTS!

SYLVANIA Luminaires

Bullet Floodlight

SYLVANIA



NEW PRODUCTS!



Product Features

- Lightweight, compact design
- Medium flood distribution
- Easy installation and adjustment with integrated knuckle
- 90% energy savings over traditional light sources

Wattage Comparison Chart

Traditional Source	Traditional System Wattage	LED System Wattage	Energy Savings
50W Halogen	50	5	90%
75W Halogen	75	15	80%
90W Halogen	90	15	83%
35 W HPS	42	15	64%
35 W HPS	42	20	52%
50 W HPS	62	20	68%
90W Halogen	90	20	78%
150 W Halogen	150	20	87%

Dimensions

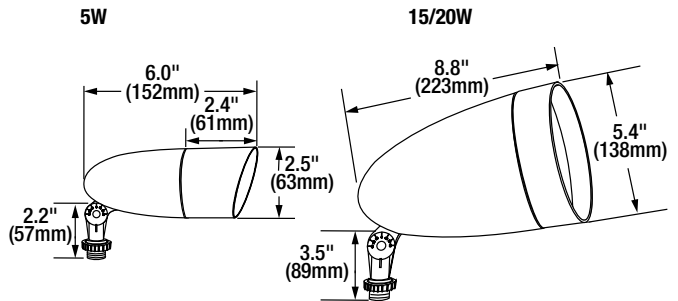

Specifications

Weight: 5W: 2.2lbs (1.0kg) 15/20W: 4.3lbs (2.0kg)

Construction: Die Cast aluminum housing with powder coat paint. The standard color is bronze.

LED System: LED system with a life rating of >150,000 hours at L₇₀ @ 25°C. Luminaire efficacy up to 110 LPW.

Electrical: Offered in 5, 15 or 20 watts, the luminaire is designed to operate through the 120-277 V_{ac} universal voltage range. The 5W LED driver has a 2kV, the 15-20W driver has 4kV inherent surge suppression, and is a constant current device. The power factor is ≥90% and THD is ≤20%.

Color Characteristics: CRI >70; CCT of 3000K, 4000K or 5000K.

Optics: UV resistant tempered glass lens.

Operating Temperature: -40°F to +104°F (-40°C to +40°C).

Listings: cULus listed to UL1598C rated for wet locations.

Warranty: Standard 5-year luminaire warranty (LEDLUM001).

Note: Specifications subject to change without notice. IES files available online.



*See page 2 for DLC listings

SYLVANIA



SMARTBUYS

Pricing valid March 1 - April 30, 2021

Capital Electric
A Sonepar Company

\$59.95 ea.



NEW!! Sylvania BULLTFL1A/005UNV740/MF/BZ 5W LED BULLET LANDSCAPE FLOOD LIGHT 120/277V (60183) [1357836]

\$69.95 ea.



NEW!! Sylvania BULLTFL1A/015UNV740/MF/BZ 15W LED BULLET LANDSCAPE FLOOD LIGHT 120/277V (60181) [1357834]

\$75.95 ea.



NEW!! Sylvania BULLTFL1A/020UNV740/MF/BZ 20W LED BULLET LANDSCAPE FLOOD LIGHT 120/277V (60179) [1357832]

SYLVANIA Luminaires

ULTRA LED™ Work Light

NEW PRODUCTS!

Application

ULTRA LED Work lights are ideal for temporary lighting with a versatile and a durable design for indoor construction and job site applications to replace HID and Fluorescent lights.

Benefits and Features

- Linkable with a wide variety of mounting options
- Integrated power cord (up to 35ft on higher wattage models)
- Strong and durable construction with a versatile design for various mounting options
- Lasts up to 5 times longer than HID lamps
- No warm-up time, instant on with full light output and stable color
- Consumes up to 74% less energy than equivalent HID lamps while delivering same light output
- Replacement for 175W-400W HID applications
- Up to 130 LPW
- 5000K color temperature
- CRI 80+
- 308° beam angle (or omnidirectional)

Electrical

- 120 VAc
- Power Factor >90%
- 6kV surge protection

Rated Life

- 50,000 hours (L₇₀)

Warranty

- Standard 5 year lamp warranty

Ambient Operating Range

- -4°F to 113°F (-20°C to 45°C)

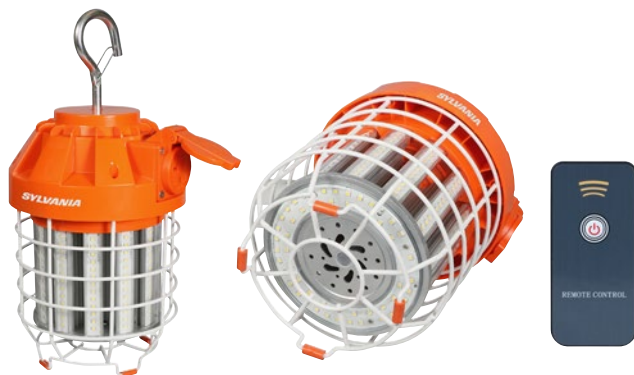

Wattage Comparison

Traditional Source	Traditional System Wattage	LED System Wattage	Energy Savings	Energy Savings Over Lamp Life
HID Metal Halide	175W	60W	74%	\$633
HID Metal Halide	250W	100W	74%	\$825
HID Metal Halide	400W	130W	73%	\$1485

*Energy savings over life of lamp calculated at \$0.11/kWh

Certifications and Listings

- IP64 Rated
- UL Damp Rated
- RoHS
- FCC*

*Class A Device (For Commercial Use - Not Residential). This device complies with part 15 of the FCC Rules. Operation is subject to the following two conditions: (1) This device may not cause harmful interference, and (2) this device must accept any interference received, including interference that may cause undesired operation. For FCC Part 15 user information, please see <http://www.sylvania.com/fccpart15a>.

Installation

- Screw in the mounting hook provided into the lamp base and hang the lamp on to a ceiling hook, if required.
- Lamp operates directly on line voltage, 120 VAc.
- For linking additional lamps, connect the power cable to the expansion outlet on the lamp.

\$82.95 ea.



NEW!! Sylvania LEDWORKLIGHT060850PLGRMT 60W LED TEMPORARY WORK LIGHT W/ 15FT CORD AND REMOTE (40974) [1616234]

\$96.50 ea.



NEW!! Sylvania LEDWORKLIGHT100850PLGRMT 100W LED TEMPORARY WORK LIGHT W/ 35FT CORD AND REMOTE (40975) [1614239]

\$119.95 ea.



NEW!! Sylvania LEDWORKLIGHT130850PLGRMT 130W LED TEMPORARY WORK LIGHT W/35FT CORD AND REMOTE (40976) [1612407]



SMARTBUYS

Pricing valid March 1 - April 30, 2021



NEW PRODUCTS!

SYLVANIA



\$155.00 ea

NEW!! Sylvania VAPOR1B065UNVD84096ECGR (60355)
8' Vaportight Fixture [1365001]



\$65.00 ea.

NEW!! Sylvania VAPOR1B040UNVD74048ECGR (74376)
4' Vaportight Fixture [1201031]



\$13.95 ea.

NEW!! Sylvania LEDRT56/120/SC3/650/WH (40637) LED
Selectable Downlight [1472974]

Ideal for retrofit applications in healthcare, hospitality, office, residential and retail using 4 inch, 5 inch & 6 inch housings.

SYLVANIA ECO LED line of products delivers a quality LED light, at an affordable price. This lasting, economical line of LED lamps provides the perfect lighting solution for any budget.



\$1.79 ea.

NEW!! Sylvania ECOLED10BR30DIM8277YVRP4/40870
10 WATT LED BR30 2700K DIMMABLE [1603812]



\$1.75 ea.



NEW!! Sylvania ECOLED5.5B10CBLUNTCL8277YVRP6
(40879) 5.5 WATT LED FILAMENT LAMP CANDELABRA
BASE [1603815]

SMARTBUYS

Pricing valid March 1 - April 30, 2021



\$4.50 ea.

NEW!! Sylvania ECOLED14PAR38830FL407YVRP2
(40881) 14W LED PAR38 3000K [1603885]

SYLVANIA Luminaires

NEW PRODUCTS!

ValueLED™ UFO High Bay

An environmentally preferable alternative to traditional luminaires and offering up to 78% energy savings, the ValueLED UFO High Bay is ideal for illuminating warehouses, gymnasiums, and other industrial applications.

Benefits and Features

- Lightweight fixture is designed for easy and safe installation
- Multiple mounting options for a variety of applications – pendant, hook, surface mount
- Mounting hook and mounting bracket included
- Variety of optics – polycarbonate refractor and aluminum reflector available
- IP65 rated aluminum body (finish is white)
- Tempered glass lens
- Up to 135 LPW
- 3500K, 4000K and 5000K color temperatures
- CRI >80
- Offered in 100, 150, 200, and 240 watts

Electrical

- Designed to operate through 120-277V (UNV) or 347-480 (HUV) V_{AC} voltage
- Power Factor >90%
- THD <20%
- 0-10V dimming
- Constant current LED driver with 4kV surge suppression

Rated Life

- ≥150,000 hours (L₇₀) @25°C

Warranty

- 5-year

Ambient Operating Range

- -40°F to +122°F (-40°C to +50°C) (100, 150 and 200W versions)
- -40°F to +113°F (-40°C to +45°C) (240W versions)

Certifications and Listings

- cULus
- RoHS
- FCC
- DLC Premium



Wattage Comparison

Traditional Source	Traditional System Wattage	LED System Wattage	Energy Savings
250W MH	290	100	66%
250W HPS	295	100	66%
320W MH	370	150	59%
400W HPS	460	150	67%
400W MH	450	150	67%
750W MH	820	200	76%
750W HPS	840	200	76%
1000W MH	1080	240	78%
1000W HPS	1100	240	78%

Installation

- Luminaire mounting options include hanging via hook, surface mounting, or pendant mounting with included mounting bracket.
- Aluminum reflector, polycarbonate refractor, and polycarbonate bottoms lens also available.
- Includes 6' power cable and 3' dimming cable.



\$99.95 ea.

NEW!! Sylvania UFOHIBA1A/100UNVD840/WH (61122)
13,000 LUMEN LED UFO HIGH BAY [1508987]



\$123.95 ea.

NEW!! Sylvania UFOHIBA1A/150UNVD840/WH (61125)
20,000 LUMEN LED UFO HIGH BAY [1486239]



\$161.95 ea.

NEW!! Sylvania UFOHIBA1A/200UNVD840/WH (61128)
26,000 LUMEN LED UFO HIGH BAY [1517014]



SYLVANIA Lamps

ULTRA LED™ High Bay



Application

ULTRA LED High Bay lamps are ideal replacements for HID indoor high bay applications.

Benefits and Features

- Lasts up to 5x longer than HID lamps
- No warm-up time, instant on with full light output and stable color
- Consumes up to 74% less energy than equivalent HID lamps while delivering same light output
- Replacement for 175W – 400W HID applications
- Up-lighting for an aesthetic lit appearance in fixtures
- Extendable base up to 50mm for better fixture compatibility
- Up to 140 LPW
- 4000K and 5000K color temperatures
- CRI 80+
- 120° directional beam angle

Electrical

- 120-277VAc
- Power Factor >90%
- 6kV surge protection
- Step dimming capability when paired with optional motion/daylight sensor and remote control

Rated Life

- 50,000 hours (L₇₀)

Warranty

- Standard 5 year lamp warranty

Ambient Operating Range

- -40°F to +122°F (-40°C to +50°C)



Wattage Comparison

Traditional Source	Traditional System Wattage	LED System Wattage	Energy Savings	Energy Savings Over Lamp Life
HID Metal Halide	175W	60W	74%	\$633
HID Metal Halide	250W	80W	73%	\$935
HID Metal Halide	400W	100W	76%	\$1650
HID Metal Halide	400W	120W	69%	\$1540

*Energy savings over life of lamp calculated at \$0.11/kWh

Certifications and Listings

- DLC 5.0 Rated
- IP64 Damp Rated
- cULus
- RoHS
- FCC
- Lead Free
- Mercury Free

This device complies with Part 15 of the FCC rules. Operation is subject to the following two conditions: (1) this device may not cause harmful interference, and (2) this device must accept any interference received, including interference that may cause undesired operation. Please visit: www.SYLVANIA.com/fccpart15b for more information.

Installation

- Requires easy ballast by-pass
- Lamp operates directly on line voltage, 120-277VAc.

NEW PRODUCTS!



1624859

\$79.95 ea.

NEW!! Sylvania LED80HIBAY840MOG (40978) 80W LED HIGH BAY REROFIT LAMP OPEN RATED 4000K [1624859]



1624862

\$85.95 ea.

NEW!! Sylvania LED100HIBAY840MOG (40972) 100W LED HIGH BAY RETROFIT LAMP OPEN RATED 4000K [1624862]



1624871

\$102.95 ea.

NEW!! Sylvania LED120HIBAY840MOG (40980) 120W LED HIGH BAY RETROFIT LAMP OPEN RATED 4000K [1624871]

Sales Note Arc flash relays



Eaton's Bussmann™ series arc flash relay (EAFR) provides unmatched switchgear protection. This relay reduces arc flash energy by quickly clearing the current feeding the arc. The sensitive light inputs with current permissive detection identify multiple arc fault conditions.

The EAFR works to detect and clear faults faster than traditional methods in medium and low voltage switchgear, and the arc flash relay modules and sensors allow for simple integration into electrical assemblies.

Flexible module options allow installers to choose between fiber optic loop cable and wired point sensors

The system can measure both light and current to eliminate nuisance operation, and offers an innovative modular design that allows for simple integration into electrical assemblies, ideal for both new and retrofit installations. The system also helps address arc flash safety concerns outlined in National Fire Protection Agency (NFPA) standard 70E, which covers employee workplace electrical safety requirements.

Bussmann series arc flash relays are now sellable through the Bussmann division.

Applications/installations

- Low voltage switchgear/switchboards
- Medium voltage switchgear
- Low/medium voltage motor control centers

Typical customers

OEMs for:

- Low voltage and medium voltage assemblies

Markets

- Oil and gas
- Industrial
- Commercial or institutional infrastructure
- Electric utilities

Target regions and countries

- United States

Key features and benefits

Feature	Benefit
An innovative module system allows for simple integration into electrical assemblies.	Ease of installation
Sensitive light inputs with current permissive detects low power phase to ground arc faults.	Arc flash reduction
The relay's configurable setup provides optional system selectivity, opening the circuit breaker closest to the arc flash.	Minimizes downtime
Flexible module options allow installers to choose between fiber optic loop cable or wired point sensors.	Ease of installation
If the point sensor option is selected, the relay can be wired and tested, reducing time and labor costs.	Modular design for easier assembly integration

Customer reaction

Reaction	Reply
I am looking for arc fault reduction in an existing installation. Is this system solely for new assembly builds?	The EAFR system is a combination of arc flash relay modules and sensors designed to detect arc flash events. With its modular design, our system makes an excellent candidate for both new and retrofit installations.
I want to avoid nuisance tripping.	The EAFR system can measure both light and current to eliminate nuisance operation.
Cybersecurity is a main concern.	Because of the simplicity of the system, all monitoring is done through contact outputs on the modules. The advantage of this approach is that cybersecurity issues are nonexistent.



NEW PRODUCTS!

RAB®



\$13.95 ea.

NEW!! RAB WFRL4R99FA120WB 4 INCH LED BAFFLE WAFER TRIM COLOR SELECT 120V [1648117]



\$35.99 ea.

NEW!! RAB G3R8930120W 3 INCH LED GIMBAL DIRECT MOUNT DOWNLIGHT 3000K 120V [1551178]



\$14.95 ea.

NEW!! RAB WFRL6R139FA120WB 6 INCH LED BAFFLE WAFER TRIM COLOR SELECT 120V [1648118]



\$39.99 ea.

NEW!! RAB G4R14930120W 4 INCH LED GIMBAL DIRECT MOUNT DOWNLIGHT 3000K 120V [1590071]



\$30.95 ea.

NEW!! RAB R2R8930120WB 2 INCH ROUND LED DIRECT MOUNT DOWNLIGHT 3000K 120V [1531749]



\$9.95 ea.

NEW!! RAB R4R89FA120WS 4 INCH COLOR SELECT LED RECESS RETROFIT SMOOTH TRIM [1600111]



\$33.95 ea.

NEW!! RAB G2R5930120W 2 INCH LED GIMBAL DIRECT MOUNT DOWNLIGHT 3000K 120V [1531750]

SMARTBUYS

Pricing valid March 1 - April 30, 2021



\$10.95 ea.

NEW!! RAB R6R89FA120WS 6 INCH COLOR SELECT LED RECESS RETROFIT SMOOTH TRIM [1550435]



LIGHTOLIER

by  Signify

Downlighting

Flat Downlight Select

4" and 6" round



Correlated Color
Temperatures



Powerful all-in-one Flat Downlight Select - Impress your toughest customer with CCT select on the fly

Powerful all-in-one Lightolier LED Flat Downlight Select - Impress your toughest customer with CCT select on the fly and contractor friendly installation connectors. Designed to significantly reduce your installation challenges on site. Get more done in less time!



1588178

\$19.95 ea.

Lightolier by Signify FD4R4CCT 4" LED Flat Direct
Mount Downlight, Color Selectable [1588178]



1588182

\$19.95 ea.

Lightolier by Signify FD6R4CCT 6" LED Flat Direct
Mount Downlight, Color Selectable [1588182]



\$46.97 ea. 

Lutron DVCL-153P-WH-2 DIVA 2-PACK PROMO WHITE LED DIMMER [1589368]

The Diva LED+ dimmer provides optimal dimming performance of LED bulbs. This dimmer works with up to 150 Watts of dimmable LED/CFL or 600 Watts of incandescent/halogen, allowing you to control multiple bulb types on the same circuit. It is designed to control a broad range of dimmable LED and CFL bulbs from a variety of brands including Philips, Cree, GE, Eco Smart and Lighting Science. The Diva dimmer features a paddle switch to turn your lights off or on---returning the lights to your favorite level. This dimmer also features a discreet slide control next to the switch, allowing you to adjust the lights for any activity. Package includes (2) Diva paddle style dimmers and (2) coordinating Claro wall plates.



Most Connected Smart Lighting Control

Caseta works with more smart home devices than any other smart lighting control brand.

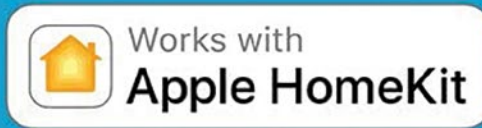

Lutron P-BDG-PKG1P CASETA SMART LAMP TIMER KIT WITH BRIDGE [1590991]

Caseta by Lutron Starter Kit with Smart Bridge, Plug-in Lamp Dimmers (1), Claro Wallplates (1), Pico Remotes (1), Individual Tabletop Pedestals (1); 100 W CFL & LED, 300 W Inc/Hal, 120V



Lutron P-BDG-PKG1W CASETA SMART DIMMER KIT WITH BRIDGE [1056335]

Caseta by Lutron Starter Kit with Smart Bridge, In-wall Dimmer (1), Claro Wallplate (1), Pico Remote (1); 150 W CFL & LED, 600 W Inc/Hal, 120V

Caséta by LUTRON

Discover the power of smart lighting



Dimmer



Remote



Fan remote



Sensor

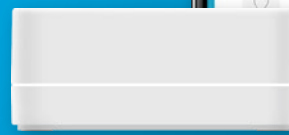

Smart Bridge

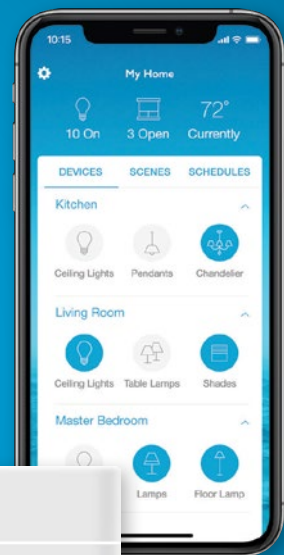

Lutron App

See your Capital Electric Sales Representative for more information.

Smart Switch Starter Kit

Homeowner benefits

- Always come back to a well-lit home
- Easily check which lights are on or off, using the Lutron App
- Add even more convenience by integrating with Siri, Alexa, or the Google Assistant
- Have outdoor lights scheduled to automatically turn on at dusk and off at sunrise

Take advantage of the geofencing feature to turn lights when you come home

Ideal for outdoor lighting

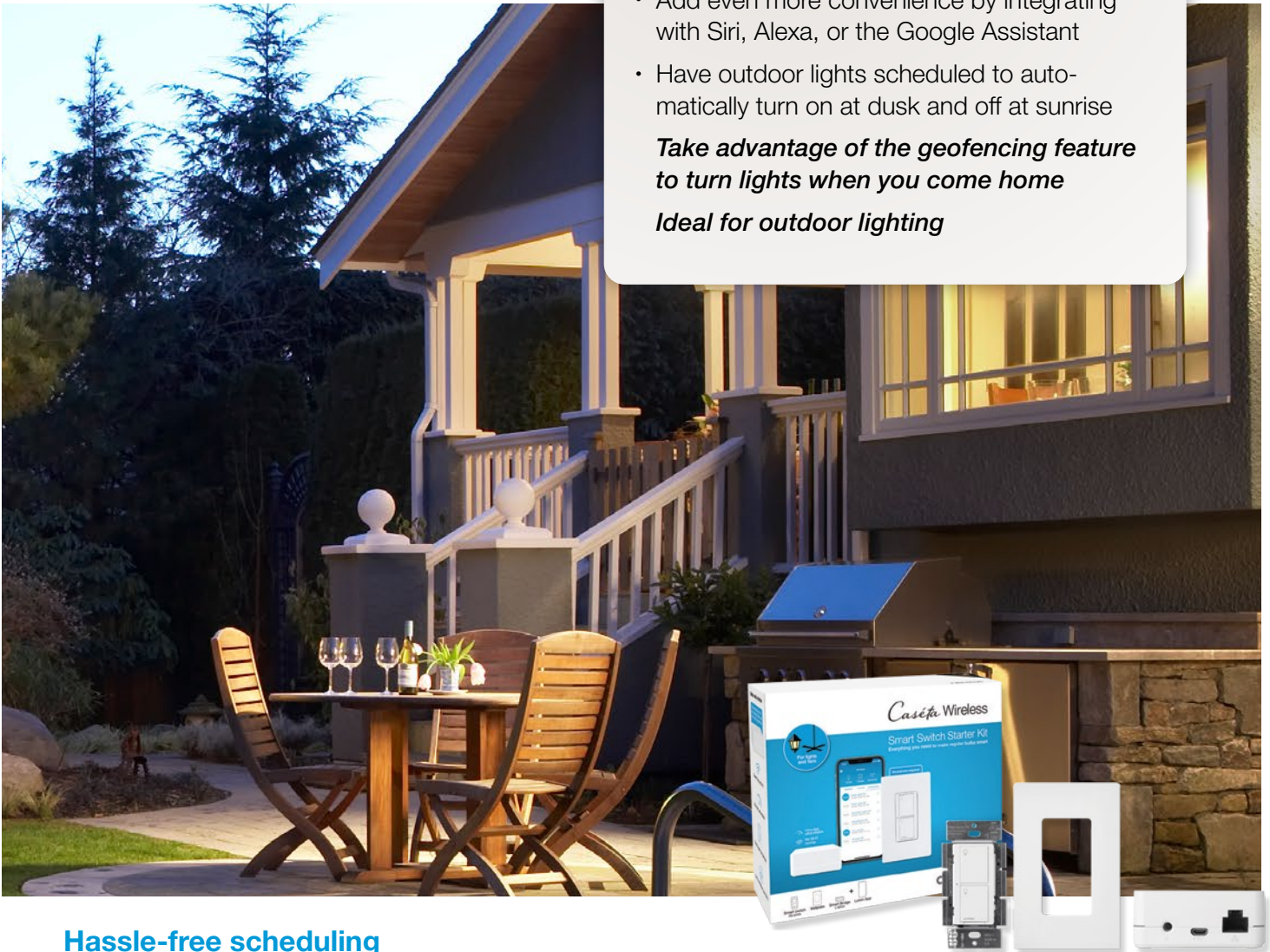

Hassle-free scheduling

- Schedule outdoor light changes by sunrise/sunset or time of day
- No need to come back and adjust the schedule for daylight saving time

Features to sell around

- Once you add the Smart Bridge, it's easy to add additional devices to the system
- Can integrate with the homeowner's favorite voice assistant
- The Smart Bridge doesn't depend on the home's Wi-Fi (if the Wi-Fi goes down, Caséta still works)

Potential add-ons

- Additional switches or dimmers throughout the home
- Pico remotes for additional points of control

You could also set up Smart Away, geofencing, and other app features, for added value for the homeowner



Dimmer Kit with Smart Bridge

Homeowner benefits

- Create the right light for any occasion
- Easily check which lights are on or off, using the Lutron App
- Add even more convenience by integrating with Siri, Alexa, or the Google Assistant

Ideal for the kitchen and living, family, and dining rooms



Add more smarts — without stress

- Easily add on to projects when you're adding retrofit light kits
- Simply plug the Smart Bridge into the router, download the Lutron App, and follow the instructions
- No neutral required —ideal for older homes

Features to sell around

- Once you add the Smart Bridge, it's easy to add additional devices to the system
- Can integrate with the homeowner's favorite voice assistant
- The Smart Bridge doesn't depend on the home's Wi-Fi (if the Wi-Fi goes down, Caséta still works)
- Dim or brighten lights to create the perfect atmosphere for any activity

Potential add-ons

- Additional switches or dimmers throughout the home
- Pico remotes for additional points of control



Not all products available at all locations. Please speak to your Capital Electric Sales Representative for more information. Capital Electric is not responsible for misprints or typos. Prices are subject to change without notice.



BR LAMPS : BR20, BR30, BR40

DESCRIPTION

LED BR Replacement Lamps directly replace incandescent BR lamps at a fraction of the energy cost.

FEATURES

- 80% more efficient and 30x longer life than standard incandescent
- Smooth body with ANSI standard form factor
- +25,000 hour rated life for ENERGY STAR® Approved lamps*
- 50,000 hour design life**
- Acceptable for ICAT rated downlights
- Shatter resistant for reduced risk of injury and breakage

WARRANTY

- 5 year limited warranty; see eiko.com for warranty details

APPLICATIONS

- Recessed Lighting
- Accent / Display Lighting
- Retail / Residential
- Hospitality
- Track Lighting
- Healthcare
- Office
- Hotel

1401185

\$2.49 ea.
EiKO LED8WBR30/827-DIM-G9 8W
LED BR30 2700K [1401185]
LED BR Replacement Lamps directly replace
incandescent BR lamps
at a fraction of the energy cost.



* Early initial qualification for ENERGY STAR allows for directional lamp life claims of 25,000 hours (L70) with 3,000 hour actual test data, LM80 data and in-situ temperature measurements. As the lamps pass ENERGY STAR requirements, manufacturers may increase the lifetime of a product as dictated by ENERGY STAR guidelines. See http://www.energystar.gov/index.cfm?fuseaction=products_for_partners.showLightbulbs for further details.

** Design life is based on engineering testing and probability analysis



PERFORMANCE	Power Consumption	7W	8W	11W	12W	17W
	Lumens	550	650	850	1,050	1,400
	Efficacy (LPW)	79	81	77	88	82
	CRI	80+				
	Beam	120°				
	CCT	2700K, 3000K, 4000K, 5000K				
ELECTRICAL	Power Factor	≥0.9				
	Input Voltage	120V				
	Life (L70)	25,000 hours*				
CONSTRUCTION	Base	E26				
	Certification(s)	ENERGY STAR® Rated; cULus Classified				
LISTINGS	Material Usage	RoHS Compliant; no mercury or lead				
	Environment	Dry and damp location rated				



SMART BUYS

Pricing valid March 1 - April 30, 2021



T8 TUBES : BYPASS/LINE VOLTAGE : 8'

T8 TUBES : BYPASS/LINE VOLTAGE : 8' DOUBLE-ENDED



\$20.95 ea.



EiKO LED43WT8/96/840-DBL-G7D 8FT LED T8 BALLAST BY-PASS LAMP SINGLE PIN 4000K [1208784]

\$20.95 ea.



EiKO LED43WT8/96/840-R17D-G8 8FT LED T8 BALLAST BY-PASS LAMP SINGLE PIN HIGH OUTPUT 4000K [1305099]

\$20.95 ea.



EiKO LED43WT8/96/850-DBL-G7D 8FT LED T8 BALLAST BY-PASS LAMP SINGLE PIN 5000K [1227221]

\$20.95 ea.



EiKO LED43WT8/96/850-R17D-G8 8FT LED T8 BALLAST BY-PASS LAMP SINGLE PIN HIGH OUTPUT 5000K [1305100]

Not all products available at all locations. Please speak to your Capital Electric Sales Representative for more information. Capital Electric is not responsible for misprints or typos. Prices are subject to change without notice.



+Advantage

A19 REPLACEMENT : E26 BASE

DESCRIPTION

LED A19 Replacement Lamps are a cost-effective, energy-efficient alternative to incandescent filament lamps.

FEATURES

- Direct replacement for 40 & 60W incandescent A lamps
- 240° beam angle is ideal for table lamps, wall sconces, and luminous globe fixtures
- 80% more efficient and 30x longer life than standard incandescent
- Smooth, clean outside housing
- Instant-On with no warm up, unlike CFLs
- Shatter resistant for reduced risk of injury and breakage
- Standard series 80+ CRI for enhanced color and lighting uniformity from lamp to lamp
-

APPLICATIONS

- Restaurants & Hospitality
- Retail
- Residential
- Accent/Display Lighting
- Healthcare



\$1.19 ea. (per lamp)

EIKO LED9WA19/ADV/827CP-G9 9W LED A19 2700K, sold in pack of 12 [1481858]

RoHS **Compliant**

cUL **US LISTED**

PERFORMANCE	Power Consumption	6W	9W
	Lumens	450	800
	Efficacy (LPW)	75	89
	Beam	240°	
	CRI	80+	
	CCT	3000K, 4000K	
	Life (L70)	10,000 hours	
ELECTRICAL	Power Factor	≥0.9	
	THD	<20%	
	Input Voltage	120VAC	
CONSTRUCTION	Operating Temperature	-4°F to 104°F (-20°C to 40°C)	
	Base	E26	
LISTINGS	Certification(s)	cULus Listed	
	Material Usage	RoHS Compliant; no mercury or lead	
	Environment	Suitable for use in damp locations	

KICHLER®

Kichler 52" LED STARKK Series Ceiling Fan

SMARTBUYS

Pricing valid March 1 - April 30, 2021



1105453



\$239.95 ea.

Kichler 330174NI 52" Starkk Ceiling Fan W/ LED Light Kit Brushed Nickel Finish [1105453]



1087091



\$239.95 ea.

Kichler 330174MWH 52" Starkk Ceiling Fan W/ LED Light Kit Matte White Finish [1087091]



1090975



\$239.95 ea.

Kichler 330174PN 52" Starkk Ceiling Fan W/ LED Light Kit Polished Nickel Finish [1090975]

GM Lighting®

"Lighting Enhanced by Design"

120V TUNABLETask™ LED Undercabinet Light Bar Specification Sheet

PRODUCT OVERVIEW

Able to achieve color temps. of 2700K, 3000K and 4000K in a single fixture, this dimmable, tunable white undercabinet fixture features excellent color rendering in a powder coated aluminum housing with polycarbonate lens. Low profile and easy to mount in 8", 16", 24" and 32" lengths.

KEY FEATURES

- Tunable white - 2700K, 3000K, 4000K
- Damp location
- Supplied with Wago® connectors
- Includes captive mounting screws
- Powder coat aluminum housing
- Low profile (15/16" depth)
- Durable polycarbonate lens with even light distribution
- Modular - easy to connect multiple fixtures for longer runs
- Dimmable (Triac)

ELECTRICAL

- 120V (remote power supply not required)
- Color temps accessed through temperature slide switch
- Rated life: 50,000 hrs.



ADJUSTABLE COLOR TEMPS
2700K - 3000K - 4000K

1481520



\$34.95 ea.

GM Lighting UCTUN-8-WH 8IN LED Undercabinet Light 2700-4000K WHIT [1481520]

1481522



\$44.95 ea.

GM Lighting UCTUN-16-WH 16IN LED Undercabinet Light 2700-4000K WHIT [1481522]

1481524



\$54.95 ea.

GM Lighting UCTUN-24-WH 24IN LED Undercabinet Light 2700-4000K WHIT [1481524]

1481526



\$67.95 ea.

GM Lighting UCTUN-32-WH 32IN LED Undercabinet Light 2700-4000K WHIT [1481526]

Not all products available at all locations. Please speak to your Capital Electric Sales Representative for more information. Capital Electric is not responsible for misprints or typos. Prices are subject to change without notice.

NEW PRODUCTS!

Elevate your design vision with just the flip of a switch with our Intrinsic Surface Mount LED Collection. The simple, classic design of these light fixtures can easily be installed into a variety of style applications in both residential and commercial settings. We offer two different sizes of surface mounts, both coated in a crisp white finish, to meet your unique design needs. Each smooth trim ring surrounds an integrated LED light fixture ready to emit general ambient lighting wherever it calls home in your design plan.

Specifications:

- Diffused polycarbonate lens
- Integrated AC LED technology 3000K, 90 CRI, 1000 lumens (delivered)
- Diffused polycarbonate lens controls direct glare from the LEDs
- Lumen output and distribution comparable to a 75W incandescent lamp
- Dimmable to 10% brightness with many Electronic Low Voltage (ELV) & Forward Phase (TRIAC) dimmers
- CSA Listed for Wet Location applications
- ENERGY STAR listed
- Meets California Title 24 - JA8 - 2019
- Fixture installs to 4" Octagon metallic junction boxes, 4" Round non-metallic junction boxes and 4" x 1/2" round ceiling pan junction box.
- Maximum 26 luminaires on a circuit (without dimmer).
- 50,000 hour rated lifetime
- Dimmable to 10% brightness (See Dimming Notes)
- Mounting strap for outlet box included
- 6 in of wire supplied

Performance:

Number of Modules	1
Input Power	15.5 W
Input Voltage	120 V
Input Frequency	60 Hz
Lumens/LPW (Delivered)	1,000/64 (LM-79)
CCT	3000 K
CRI	90 CRI
Life (hours)	50000 (L70/TM-21)
EMI/RFI	FCC Title 47, Part 15, Class B
Min. Start Temp	-30 °C
Max. Operating Temp	30 °C
Warranty	5 year warranty
Labels	cCSAus Wet Location Listed
	ENERGY STAR® qualified
	Meets California Title 24 JA8-2019

PROGRESS
LIGHTING™



1544346

\$10.95 ea.
NEW!! Progress Lighting
P810012-028-30 5" LED
Surface Mount Trim [1544346]

1527084

\$13.95 ea.
NEW!! Progress Lighting
P810013-028-30 7" LED
Surface Mount Trim [1527084]

SMART BUYS

Pricing valid March 1 - April 30, 2021

 **Capital Electric**
A Sonepar Company

nVent ERICO Cadweld Plus Impulse Exothermic Welding Control Unit



CONNECT AND PROTECT

Our latest innovation, the **nVent ERICO Cadweld Plus Impulse Exothermic Welding Control Unit**, brings you the highest level of flexibility and ease of use of any of our ignition systems. Precision engineered, the control unit lets you choose your power source: from off-the-shelf AA-batteries to the rechargeable Lithium-Ion packs you have on your job site.

Why should you choose our latest ignition system? Safety, power and ease-of-use.

SAFETY

- Self-closing trigger guard prevents accidental ignition, providing added safety
- LED ignition counter provides instant feedback on the timing of the ignition and is visible in sunny outdoor conditions
- Five second delay in ignition is a safety feature to allow the user to stop ignition, if necessary

POWER

- Battery life indicator integrated into the unit for real-time updates on battery life; compatible with both AA and rechargeable batteries
- Includes AA alkaline batteries to power approximately 600 connections
- Rechargeable batteries from Milwaukee® or DEWALT® can be used to power approximately 1500 connections using a 4Ah battery
- Battery adapters available for use with either Milwaukee® or DEWALT® rechargeable batteries (sold separately)

EASE-OF-USE

- High temperature lead with single molded insert into the control unit keeps the most-often replaced component of ignition systems more securely attached and reliable
- Easy-to-use alligator clip design of the termination clearly shows a positive connection in the viewing window
- Enhanced power tool style grip is ergonomic and easy to hold



Part Number	Cable Length	Batteries	Working Temperature
PLUSCU2L6	6'	8 Standard AA Batteries	0 – 130 °F
PLUSCU2L15	15'	8 Standard AA Batteries	0 – 130 °F

Not all products available at all locations. Please speak to your Capital Electric Sales Representative for more information. Capital Electric is not responsible for misprints or typos. Prices are subject to change without notice.

WHAT'S INCLUDED

Part Number	Item Description	Control Unit	Leads	AA Batteries	Battery Adapter
PLUSCU2L6	Control Unit with 6' Lead	Base Control Unit	6' length	8 Alkaline	For AA batteries
PLUSCU2L15	Control Unit with 15' Lead	Base Control Unit	15' length	8 Alkaline	For AA batteries
PLUSCU2RLD6	Replacement Lead, 6'		6' length		
PLUSCU2RLD15	Replacement Lead, 15'		15' length		
PLUSCU2BAA	AA Battery Adapter				For AA batteries
PLUSCU2BM	Milwaukee® Battery Adapter				For Milwaukee® 18V rechargable batteries
PLUSCU2BD	DEWALT® Battery Adapter				For DEWALT® 20V rechargable batteries

The control unit is part of the nVent ERICO Cadweld family, which includes:

1. Standard and custom exothermic mold configurations
2. Welding material
3. Tools and accessories

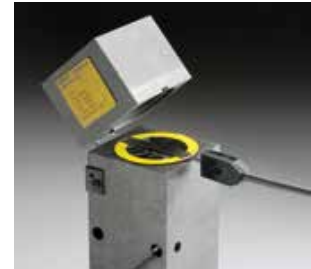

See your Capital Electric Sales Representative for more information.



Our powerful portfolio of brands:

CADDY ERICO HOFFMAN RAYCHEM SCHROFF TRACER

©2020 nVent. All nVent marks and logos are owned or licensed by nVent Services GmbH or its affiliates. DEWALT is a registered trademark of Black & Decker Corporation. Milwaukee is a registered trademark of Milwaukee Electric Tool Corporation. All other trademarks are the property of their respective owners. nVent reserves the right to change specifications without notice. ERICO-DS-H85758-CadweldImpulse-USEN-2006

NEW PRODUCTS!

nVent CADDY Heavy Duty Telescoping Bracket

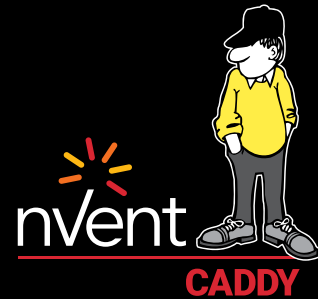

CONNECT AND PROTECT

For ultimate stud-wall flexibility and snap-in time savings, choose the nVent CADDY Heavy Duty Telescoping Bracket and Box Mounting Plate. We created this product grouping after listening to the electrical contractor community, designing a solution that makes the job easier, repeatable and reliable. The result is a system based on a telescoping bracket that adapts to studs spaced 16" to 24", and a snap-in box mount with ultimate flexibility.

Made to work with data and electrical applications, choose the telescoping bracket and box mounting products for your next job; and provide your team the flexibility they need – with the confidence that it is installed right the first time.

HEAVY DUTY TELESCOPING BRACKET



NEW!! nVent CADDY TB1624HD
[1573014]

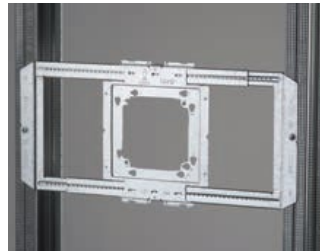

- Maximize speed and job efficiency with snap-on box mounting plates (sold separately)
- Install box mounting plates with a just a snap; securely at any position in the telescoping bracket
- Rigid design eliminates the need for far-side support
- Repeatable, time-saving design is ready to use right from the box
- Compatible with wood or metal studs, spaced from 16" to 24"

Part Number	Material	Finish	Stud Spacing Adjustability	Box Size	Standard Packaging Quantity
TB1624HD	Steel	Pregalvanized	14 1/2" – 25"	4" 4 11/16" 5"	25 pc

BOX MOUNTING PLATE



NEW!! nVent CADDY TB45P
[1573015]



- Works with our Heavy Duty Telescoping Bracket - just snap it in
- Flexible installation options also allow mounting direct to metal or wood studs
- Multiple key hole configurations for ease of installation and visual location confirmation
- Adapt with confidence to any situation; with low voltage extruded holes and the ability to remove and reinstall screws multiple times without compromise
- Works with vertically or horizontally-mounted single and double gang adjustable mud rings
- Ready for prefabrication and job-site adjustments with a specially-designed tab that holds strong without locking in place

Part Number	Material	Finish	Box Size	Standard Packaging Quantity
TB45P	Steel	Pregalvanized	4" 4 11/16" 5"	25 pc

BOX MOUNTING PLATE WITH FAR SIDE SUPPORT

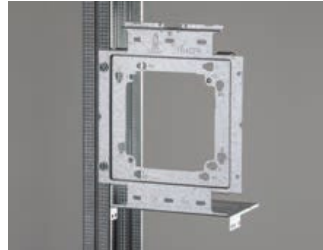
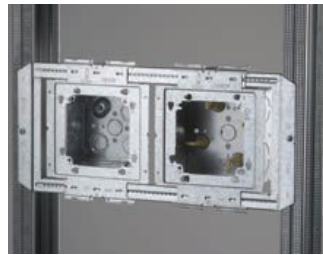

Far side support allows you to install on any stud depth and width

- Works with our Heavy Duty Telescoping Bracket - just snap it in
- Flexible installation options also allow mounting direct to metal or wood studs
- Far side support allows you to install on any stud depth and width
- Multiple key hole configurations for ease of installation and visual location confirmation
- Adapt with confidence to any situation; with low voltage extruded holes and the ability to remove and reinstall screws multiple times without compromise
- Works with vertically or horizontally-mounted single and double gang adjustable mud rings
- Ready for prefabrication and job-site adjustments with a specially-designed tab that holds strong without locking in place

Part Number	Material	Finish	Box Size	Standard Packaging Quantity
TB45PK	Steel	Pregalvanized	4" 4 11/16" 5"	25 pc

Box Mounting Plate – Detailed View

Prefabrication Tab in Bent Position

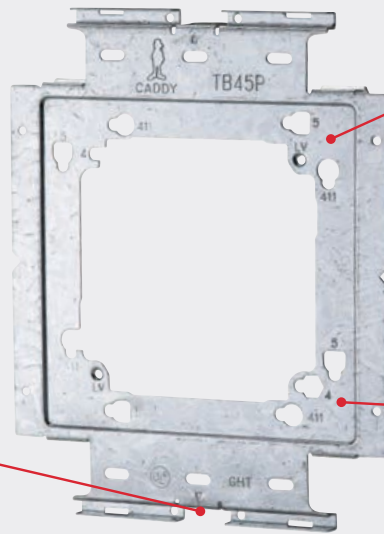

Low Voltage Extruded Hole

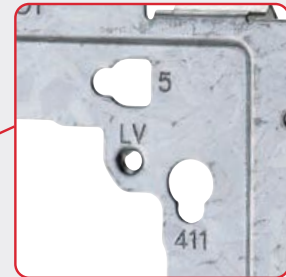

Keyholes

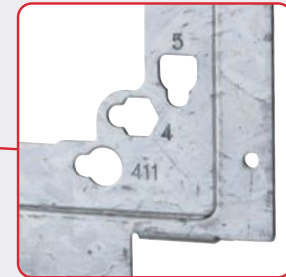

Our powerful portfolio of brands:

CADDY ERICO HOFFMAN RAYCHEM SCHROFF TRACER

©2020 nVent. All nVent marks and logos are owned or licensed by nVent Services GmbH or its affiliates. All other trademarks are the property of their respective owners. nVent reserves the right to change specifications without notice.

CADDY-DS-H86001-TB1624HD-USEN-2004

nVent CADDY First Means of Securement for Heavy Duty Box Bracket

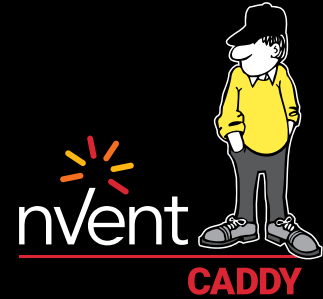

CONNECT AND PROTECT



Material: Steel
Finish: Pregalvanized

FEATURES

- Provides first means of securement for MC/AC and EMT conduit
- Works with Heavy Duty Rigid Box Support and Heavy Duty Telescoping Bracket
- Snaps into channel and locks into place without screws
- Rigid locking tab securely locks into place when closed and opens for easy conduit placement



**nVent CADDY FM4 KT
SECUREMENT 4" BOX**
[1642724]



**nVent CADDY FM411 BKT
SECUREMENT 4-11/16" BOX**
[1642727]

Part Number	Box Size	EMT Conduit Size	MC/AC Cable Size	Certifications	Standard Packaging Quantity
FM4	4"	3/4"	14-2 to 12-3	UL	20 pc
FM411	4 11/16"	3/4"	14-2 to 12-3	UL	20 pc



Our powerful portfolio of brands:

CADDY ERICO HOFFMAN RAYCHEM SCHROFF TRACER

NEW PRODUCTS!

nVent CADDY Glider Electrical Box Attachment, Screwless

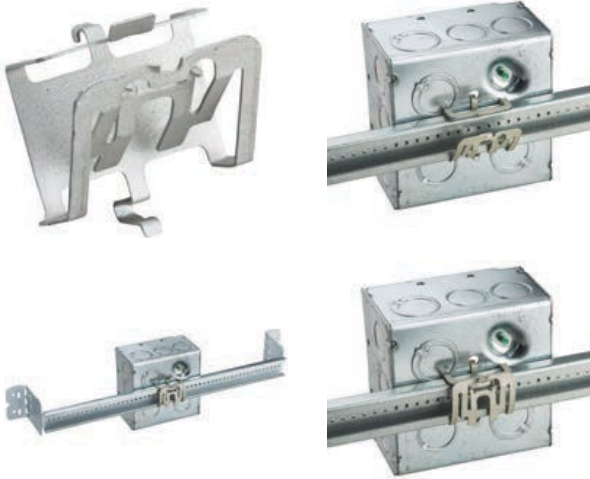
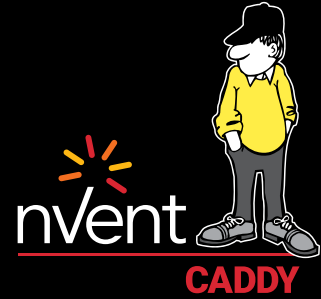

FEATURES

- Secures electrical boxes to the TSGB without tools or screws
- Innovative design securely clips onto electrical box eliminating attachment screw
- Electrical boxes can be easily positioned along TSGB
- Allows closer installation of multiple boxes between or against the studs
- Allows for easy repositioning of electrical boxes
- Ideal for pre-fab assemblies
- Allows for fast and easy opening and closing



NEW!! nVent CADDY TSGLDR2
[1579994]



Part Number	Material	Finish	Standard Packaging Quantity
TSGLDR2	Spring Steel	nVent CADDY Armour	100 pc



Our powerful portfolio of brands:

CADDY ERICO HOFFMAN RAYCHEM SCHROFF TRACER

Snap to Stud Cable Support, Screwless

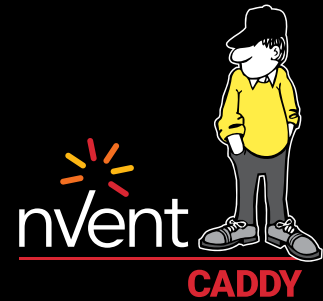

FEATURES

- Snap to stud feature makes installation fast and easy, saving time and increasing productivity
- No tools or fasteners needed for installation
- Does not require screws for UL certification
- Easy-to-use locking tab
- Cable locating ribs to maintain cable separation
- Flared edges for cable protection
- NEC® 300.4D applicable



Part Number	Material	Finish	Certifications	Standard Packaging Quantity
CJ6STS	Steel	Pregalvanized	cULus	100 pc

Cable Type	Cable Size	Cables Per Fastener
Non-Metallic Sheathed Cable	14-2, 12-2, 10-2, 14-3, 12-3 and 10-3 w/ground	6 Max
	8-2 and 6-2 w/ground	4 Max
Metal Clad (MC)	14-2, 12-2, 10-2, 14-3, 12-3, 10-3, 14-4, 12-4 and 10-4 w/ground	4 Max
Armored Cable (AC)	14-2, 12-2, 10-2, 14-3, 12-3, 10-3, 14-4, 12-4 and 10-4 w/ground	4 Max
Flexible Metal Conduit (BX)	3/8"	4 Max



Our powerful portfolio of brands:

CADDY ERICO HOFFMAN RAYCHEM SCHROFF TRACER



Legrand Cablofil Cable Trays

The Cablofil Wiremesh Cable Tray concept is based upon performance, safety and economy; three qualities which make Cablofil Wiremesh Cable Tray system preferred by installers. Cablofil adapts to the most complex configurations, and its structure gives maximum strength for minimum weight. The ease of creating fittings, carried out on site, as well as the wide range of unique and universal accessories gives complete freedom in routing combined with exceptionally fast installation.

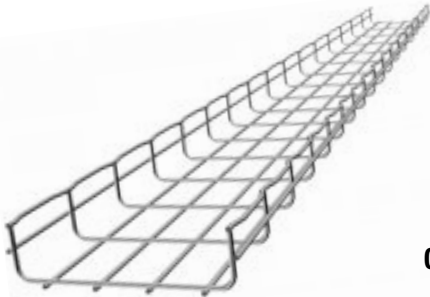

322154

**Cablofil Legrand
CF54/150EZ
Cable Tray** [322154]

96225

**Cablofil Legrand
CF54/200EZ
Cable Tray** [96225]

96583

**Cablofil Legrand
CF54/300EZ
Cable Tray** [96583]



94440

**Cablofil Legrand
CF105/300EZ
Cable Tray** [94440]

95190

**Cablofil Legrand
CF105/450EZ
Cable Tray** [95190]

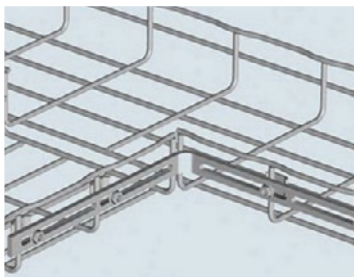

99642

**Cablofil Legrand
EZT90EZ
90° Bend and T Kit** [99642]



NEW PRODUCTS!



1566222

\$27.95 ea.
NEW!! Fanlight NaturaLED 9410
FXSECW15/840/DB/MV [1566222]

1566225

\$36.95 ea.
NEW!! Fanlight NaturaLED 9412
FXSECW30/840/DB/MV [1566225]



1456352

\$89.95 ea.
Fanlight NaturaLED 4560
LED36PWL/FR33/850 36W LED
Portable Work Light [1456352]

\$119.95 ea.
Fanlight NaturaLED 4561
LED93PWL/FR70/850 93W LED
Portable Work Light

SMARTBUYS

Pricing valid March 1 - April 30, 2021



Not all products available at all locations. Please speak to your Capital Electric Sales Representative for more information. Capital Electric is not responsible for misprints or typos. Prices are subject to change without notice.



Square D QO Plug-on Neutral

Industry's Leading Feature for Load Centers and Advanced Function Circuit Breakers

Due to its overwhelming success, Square D by Schneider Electric now offers all QO single-phase, convertible main Load Centers, 12 spaces and greater with the industry's leading PoN architecture.

Designed for reliability, the QO™ Plug-on Neutral CAFI Circuit Breakers connect directly to the neutral bar, providing a time and labor-saving installation.

Accessories and covers listed for use with standard QO Load Centers are listed for use with QO PoN Load Centers as well.

QO PoN Load Centers are now listed for use QO Tandem Circuit Breakers (QO T non-CTL) which increase the number of circuits a Load Center can facilitate QO PoN Load Centers are also fully compatible with "pig-tail" circuit breakers.

PoN benefits have proven to bring:

- **Fewer connections:** Saves time & Reduces mistakes that lead to call backs
- **Reduced wire in the gutter:** Easier to work, more professional appearance
- **Elimination of pigtail wiring mistakes** by providing a reliable neutral connection
- All these attributes contribute to a **lower total installed cost**

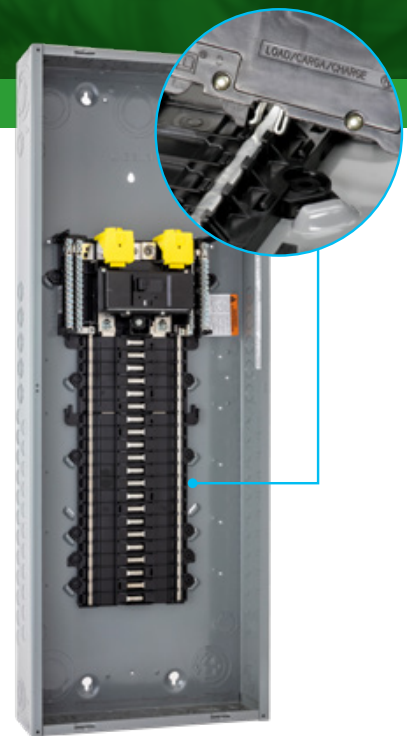

Life Is On



by Schneider Electric

NEW PRODUCTS!

QO™/Homeline™ 2-Pole Ground-Fault Circuit Breakers



Compliant with NEC® GFCI requirements

Features:

- Square D™ Qwik-Gard circuit breakers provide overload and short circuit protection combined with Class A ground fault protection for people.
- QO GFI circuit breakers feature Visi-Trip™ for visual trip indication.
- Complies with UL 943 standard for GFCI protection.



2-Pole GFI Circuit Breakers from Square D™ by Schneider Electric:

Ampere Rating	Qwik-Gard 2P common trip GFI circuit breakers		
	QO Plug-on - 120/240 Vac	QOB Bolt-on - 120/240 Vac	Homeline Plug-on - 120/240 Vac
	10 k AIR - 2 spaces required	10 k AIR - 2 spaces required	10 k AIR - 2 spaces required
15	QO215GFI	QOB215GFI	HOM215GFI
20	QO220GFI	QOB220GFI	HOM220GFI
25	QO225GFI	QOB225GFI	HOM225GFI
30	QO230GFI	QOB230GFI	HOM230GFI
35	QO235GFI†	QOB235GFI†	HOM235GFI†
40	QO240GFI	QOB240GFI	HOM240GFI
45	QO245GFI†	QOB245GFI†	HOM245GFI†
50	QO250GFI	QOB250GFI	HOM250GFI
60	QO260GFI	QOB260GFI	–
60 A	QO260GFI3W	–	–

†New Additions: For 2P 60A 3W GFI order QO260GFI3W



by **Schneider Electric**

Square D™ Residential Enclosed Circuit Breakers are designed to be code compliant, easy to install, customizable and highly reliable. These rainproof Residential Enclosed Circuit Breakers are suitable for use only as service equipment since they feature a UL67 service entrance barrier, factory applied Emergency Disconnect and Service Entrance labels, and the ability to select between factory installed molded circuit breakers (150 200A @ 25k AIR) or field installable molded circuit breakers (70 200A @ up to 100k AIR).

Service Entrance Devices

Table 1.91: Residential Enclosed Circuit Breakers with PowerPact Q Frame MCBs

Enclosure	Mains Rating	Short Circuit Rating	Commercial Reference	Included in Package
Rainproof NEMA 3R	150A	25kA	Q2150MRBE	Factory Installed: (1) QDL22150, (1) service entrance barrier, (1) emergency disconnect label & (1) service disconnect label
Rainproof NEMA 3R	200A	25kA	Q2200MRBE	Factory Installed: (1) QDL22200, (1) service entrance barrier, (1) emergency disconnect label & (1) service disconnect label



Square D Q2150MRBE Service Entrance Residential Enclosure MB 150A [1617629]



Square D Q2200MRBE Service Entrance Residential Enclosure MB 200A [1617259]

SMARTBUYS

Pricing valid March 1 - April 30, 2021



See your Capital Electric Sales Representative for more information.

AC/MC fittings

ACB series

ACB SERIES – STEEL & MALLEABLE IRON

Applications:

- ACB Series Connectors are used to connect armoured cable, metal-clad cable or flexible metallic conduit to a box or enclosure

Features:

- Dual gripping saddle design on the connector safely secures cable or conduit in place and prevents loosening from vibration
- Insulated throat provides a smooth pulling surface that won't strip cable
- Angled teeth on locknut bite into enclosure, preventing loosening from vibration
- Tri-head set screw may be installed using a slotted, Phillips or Robertson head screwdriver
- Steel connector is zinc electroplated for corrosion resistance

Listed for use with:

- Flexible Metal Conduit (RWFMC): 3/8" - 4"
- Armoured cable (AC): 3/8" - 1 1/4"
- MC cable (MC): 3/8" - 3"
- MCI-A cable (MCI-A): 3/8" - 1 1/4"

Straight connectors

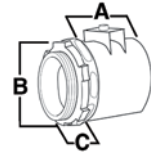

Cat. #	Trade size	Cable opening		Unit qty.	Dimensions		
		Max.	Min.		A	B	C
ACB38	3/8"	0.660	0.400	50	1 3/16"	1 1/4"	1/2"
ACB50	1/2"	0.920	0.520	25	1 3/8"	1 1/4"	7/16"
ACB75	3/4"	1.110	0.680	10	1 7/8"	1 1/16"	7/16"
ACB100	1"	1.380	0.880	5	1 9/16"	1 13/16"	1/2"
ACB125	1 1/4"	1.635	1.150	5	2 1/16"	2 1/8"	5/8"
ACB150	1 1/2"	1.950	1.490	5	2 1/8"	2 1/2"	5/8"
ACB200	2"	2.450	1.765	1	2 3/16"	3"	5/8"
ACB250	2 1/2"	3.060	2.270	1	2 11/16"	3 5/8"	13/16"
ACB300	3"	3.560	3.160	1	2 13/16"	4 1/4"	15/16"
ACB350	3 1/2"	4.060	3.860	1	2 15/16"	3 3/4"	1"
ACB400	4"	4.560	4.360	1	3"	5 3/16"	1 1/16"

45° connectors

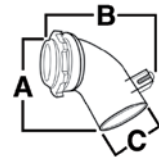

Cat. #	Trade size	Cable opening		Unit qty.	Dimensions		
		Max.	Min.		A	B	C
ACB3845	3/8"	0.660	0.400	50	1 13/16"	1 13/16"	15/16"
ACB5045	1/2"	0.920	0.520	25	2 1/8"	2 1/8"	1 1/4"
ACB7545	3/4"	1.110	0.680	10	2 3/8"	2 3/8"	1 1/8"

90° connectors

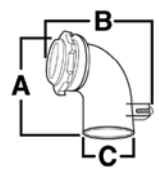

Cat. #	Trade size	Cable opening		Unit qty.	Dimensions		
		Max.	Min.		A	B	C
ACB3890	3/8"	0.660	0.400	50	1 3/4"	2 1/16"	1"
ACB5090	1/2"	0.920	0.520	25	2 1/8"	2 1/4"	1 1/4"
ACB7590	3/4"	1.110	0.680	10	2 1/2"	2 1/2"	1 3/8"
ACB10090	1"	1.380	0.880	5	2 13/16"	2 7/8"	1 11/16"

AC/MC fittings

Certifications and compliances:

- UL Listed
- cUL Listed
- UL File No. E-19188

Standard materials and finishes:

- Body – straight: steel, zinc electroplated
- Body – 45° and 90°: malleable, zinc electroplated
- Saddle – steel, zinc electroplated
- Screw – steel, zinc electroplated
- Insulated throat – thermoplastic, natural



SMART BUYS

Pricing valid March 1 - April 30, 2021



Powering Business Worldwide

GENERAC®

Protector® Series

Protector® Series

PROTECTOR® SERIES Standby Generators Liquid-Cooled Gaseous Engine

INCLUDES:

- Two-Line LCD Multilingual Digital Evolution™ Controller (English/Spanish/French/Portuguese) with external viewing window for easy indication of generator status and breaker position.
- Capability to be installed with 18" (457mm) of a building*
- True Power™ Electrical Technology
- Isochronous Electronic Governor
- Sound Attenuated Enclosure
- Closed Coolant Recovery System
- Smart Battery Charger
- UV/Ozone Resistant Hoses
- ±1% Voltage Regulation
- Natural Gas or LP Operation
- 5 Year Limited Warranty
- UL 2200 Listed

Note: 25-45 kW units are field convertible between natural gas or liquid propane. 60 kW units are built per fuel requirement and are not convertible.

*Only if located away from doors, windows, and fresh air intakes, and unless otherwise directed by local codes. Applicable for 25kW and 30kW units only.

Standby Power Rating

Model RG025 (Aluminum - Bisque) - 25 kW 60 Hz
Model RG030 (Aluminum - Bisque) - 30 kW 60 Hz
Model RG036 (Aluminum - Bisque) - 36 kW 60 Hz
Model RG045 (Aluminum - Bisque) - 45 kW 60 Hz
Model RG060 (Aluminum - Bisque) - 60 kW 60 Hz



QUIET-TEST™

*Assembled in the USA using domestic and foreign parts.

Meets EPA Emission Regulations
25, 30 & 45 kW CA/MA emissions compliant
36 & 60 kW not for sale in CA / MA

1071153



Generac RG02515ANAX RG SERIES GENERATOR 25KW
120/240V 1PHASE NG [1071153]

1036446



Generac RG03015ANAX RG SERIES GENERATOR 30KW
120/240V 1PHASE NG [1036446]

1035548



Generac RG03624ANAX RG SERIES GENERATOR 36KW
120/240V 1PHASE NG [1035548]

1079259



Generac RG04524ANAX RG SERIES GENERATOR 45KW
120/240V 1PHASE NG [1079259]

1019916



Generac RG06024ANAX RG SERIES GENERATOR 60KW
120/240V 1PHASE NG [1019916]

PRODUCT LAUNCH

Plugload Controllable Receptacles

Half & Dual Controllable Decorator Receptacles



PASS & SEYMOUR

Product Features & Benefits

.032 inch thick, brass, triple-wipe power contacts for lasting retention.

Two drive screws anchor strap to back body and face where abrupt removal torque is strongest.

Can be used to control loads using WattStopper® DLM and other building control systems.

Also available: Half-controlled version, that features a factory-broken split-circuit tab, allowing for half of the receptacle to be controlled.



26352CD-GRY

Auto-ground clip assures positive ground.

Controlled receptacle marking is NEMA-approved and compliant with 2014 NEC®.

Corrosion-resistant, plated steel strap locked into face and back body to resist pulling away from face/body assembly.

Tri-drive steel terminal screws. Internal screw-pressure-plate back and side wire capability. Two back wire holes for more wiring flexibility.



PASS & SEYMOUR®

Specification Grade Weather-Resistant USB Charging Receptacles 15 & 20A, Tamper-Resistant

Spec and install the toughest outdoor USB charging receptacle in the industry

WRTR15USBAC6, WRTR20USBAC6

Install the fastest Weather-Resistant USB charging receptacle on the market. Industry-leading charging capacity of 6.0A, shared between both ports. Charge your smartphones, tablets, and laptops up to 40% faster than 3-5A USB chargers, while enjoying the added safety of tamper-resistant receptacles that meet NEC® requirements for outdoor use. These USB receptacles are UL listed to UL498 for weather resistance and comply with section 406.9 of the National Electrical Code. Protects children: patented shutter system helps prevent improper insertion of foreign objects – now with black "invisi-shutters" for an invisible effect. The external brass back wire pressure-plate and posted side-wire terminal screws make installation fast and easy. RoHS compliant.



Features & Benefits

Posted terminal screws and external back-wire pressure plates for more productive and reliable terminations.

AC USB receptacles available in 15 and 20A, 125V Specification Grade and Hospital Grade.

- **Complies with Section 406.9 of the National Electrical Code for weather resistance. Multiple color options available.***
- **Efficient power supply** meets the Department of Energy (DoE) Level VI no-load power requirement of 100mW max for external power supplies.

*Must be installed with a weatherproof cover. It is recommended that these devices are installed in a wall box measuring at least 3" x 2" x 2-1/2" to ensure proper NEC Article 314 box fill requirements. For retrofit applications a Weatherproof extension ring may be required on boxes with less depth than 2-1/2".



WRTR20USBAC6LA

Available with (1) USB Type-A & (1) USB Type-C port or (2) USB Type-C ports to charge the latest mobile devices.

Reinforced nylon USB Type-A ports to withstand abuse over the life of the product.

Type-A and Type-C ports carry a minimum rating of 10,000 insertions.

AC USB receptacles are tamper-resistant to meet NEC. Patented shutter system – now with black "invisi-shutters" for an invisible effect preferred by end-users – helps prevent improper insertion of foreign objects.

Stainless steel auto-ground clips assure positive ground.



3rd Party Compliance



cULus Listed, UL Listed
Complies with test requirements UL 498, UL 1310, Federal Specification WC-596,
CSA C22.2 No. 42, CSA C22.2 No. 223

See your Capital Electric Sales Representative for more information.

COMING SOON!



ModPower

WIREMOLD

designed to be better.™



Legrand is excited to bring to market the first product evaluated and listed to the new UL 962A Supplement SD (Furniture Power Distribution Units for Portable (Moveable) Work Space Tables).

These products are designed to allow for the primary unit to be connected to a wall or floor outlet, via a non-detachable power supply cord. Up to (5) additional units may be connected to the primary unit via interconnecting cords that utilize grounding-type Non-NEMA style connectors.



HUBBELL®
Wiring Device-Kellems

WATERTIGHT WIRING DEVICES

For the Most Demanding Environments.



The Watertight Wiring Devices line can stand up to regular facility wash-downs, survive mud and standing water, and withstand severe weather exposure.

Typical Applications

- Food Processing
- Water Treatment
- Agriculture
- Outdoor Entertainment
- Amusement Parks
- Factories



HUBBELL®
Wiring Systems



936341



\$35.99 ea.

Kidde 21006377-N KN-COSM-IBA - Hardwired Combination Carbon Monoxide & Smoke Alarm [936341]

The Kidde KN-COSM-IBA uses breakthrough technology to offer a fast response to real fires, including smoldering and fast-flaming, as well as protect you from carbon monoxide and dramatically reduce the chance of nuisance alarms. The Intelligent sensor technology combines the detection capabilities of an ionization smoke sensor – which is more likely to detect smaller, less visible fire particles, like those produced by flaming fires – with that of an electrochemical sensor, which is used to detect CO. Since carbon monoxide is present in all fires, having both detection chambers work together in one alarm is a breakthrough in the fire safety industry. When either sensor notices a potential hazard, it will communicate with the other. Depending on what is detected, the alarm will adjust its smoke sensitivity in order to better discriminate between a real hazard and a false one.

428802



\$8.50 ea.

Kidde 21007581 Firex Hardwired Smoke Alarm - Firex I4618 [428802]

The Kidde i4618 is an AC/DC powered, ionization smoke alarm that operates on a 120V power source with 9V battery backup. This alarm uses ionization sensing technology. Ionization sensing alarms may detect invisible fire particles (associated with flaming fires) sooner than photoelectric alarms. Photoelectric sensing alarms may detect visible particles (associated with smoldering fires) sooner than ionization alarms.



**It's 2021.
Replace alarms now
and don't think
about it again
until 2031.**



**Kidde 10-year sealed battery
Smoke & CO alarms meet code
and save money over the life of
the alarm.**

**Kidde's 10-Year alarms use one battery for
the life of each alarm to provide 24/7
protection. Kidde 10-Year alarms are UL
Listed, have a 10-Year sealed lithium battery,
a 10-year life, and a 10-year warranty.**

**Make a resolution to protect your home, your family, and your customers with
Kidde Fire Safety products. Available at your local Capital Electric branch.**





As temperatures drop, the risk of carbon monoxide related illnesses rise.

Anytime a fuel burning appliance malfunctions or is improperly installed, CO can quickly reach dangerous levels in the home.

CARBON MONOXIDE SOURCES



vehicles running in garages



fireplaces



gas powered heaters



gas & oil
water heaters



gas cooking appliances

Carbon Monoxide is the #1 cause of accidental poisoning deaths in the US.

CO is often called the silent killer because it is odorless, colorless, and tasteless. The only safe way to detect the harmful gas is to install a working CO alarm on each level of the home and near sleeping areas.

Are your customers protected?

STOCK UP ON YOUR NEXT TRIP TO CAPITAL ELECTRIC

Worry-Free Hardwired Combo Alarm with 10yr with battery backup | 21010408-N

Worry-Free Hardwired Interconnect Smoke Alarm with 10yr battery backup | 21010407-A

Hardwired Combo Alarm | 21006377-N

AC Hardwired CO Alarm | 21006406

Safety during all seasons starts with Kidde.



Broan NuTone AE50110DCL FLEX DC Series Bathroom Exhaust Fan With LED light and Selectable CFM, 50-80-110 [1458093]



Broan NuTone AE50110DC FLEX DC Series Bathroom Exhaust Fan With Selectable CFM, 50-80-110 [1452047]

Ensure comfort in your bathroom with the Broan Flex DC™ Series Bathroom Exhaust Ventilation Van! This Energy Star certified multi-speed fan gives professionals the flexibility to handle new construction or room-side retrofit installations. This ceiling mounted bathroom exhaust ventilation fan has selectable CFM settings at 50, 80, or 110 running at a quiet operation of <math><0.3-0.4-0.9</math> sones and is recommended for bathrooms up to 105 sq. ft. The powerful ventilation reduces humidity to quickly eliminate fogged mirrors and manage moisture. The plug-in, permanently lubricated brushless DC motor is engineered for continuous operation. The compact housing is designed to mount directly to inboard joists, making retrofit or new installation applications easy and simple. Snap-fit Flange Kit will cover the edges of the cutout for a more professional finish and a tighter, leak-free seal. With our TrueSeal™ damper technology, Flex DC fans reduce air leakage by up to 50% compared to competitive models, resulting in better home performance via blower door tests and reducing cold and warm air back drafts. Retrofit installation is easy and can be done entirely room-side - no need to crawl up into your attic! It can be used over the bathtub or shower with the GFCI circuit. It can also be installed in a wall if mounted 8-ft. or more above the floor. Upgrade your bathroom with the Broan Flex DC™ Series Bathroom Exhaust Ventilation Van!

BROAN
NuTone

SMART BUYS

Pricing valid March 1 - April 30, 2021

 **Capital Electric**
A Sonepar Company

ET Basic+ Series

365/24-Hour and 365/7-Day Electronic Controls



Convenient Scheduling, Seamless Integration

Simplify lighting and load schedules, reduce maintenance issues and boost energy efficiency with ET Basic+ Series Electronic Controls. The upgraded controls bring convenience and versatility to a wide range of indoor and outdoor applications and include enhanced features, such as a USB port for schedule backups or transfers. The series includes 24-hour, 7-day or 7-day Astronomic programming options.

\$171.91 ea.



Intermatic ET1105C 24-Hour 1 Circuit Electronic Control, 120-277 VAC, 60 HZ, SPST, Indoor Metal Enclosure [261755]

\$190.98 ea.



Intermatic ET1705C 7-Day 1-Circuit Electronic Control, 120-277 VAC, 60 HZ, SPST, Indoor Metal Enclosure [281227]

\$193.40 ea.



Intermatic ET1125C 24-Hour 2-Circuit Electronic Control, 120-277 VAC, 60 HZ, 2-SPST, Indoor Metal Enclosure, Mexico Sales Only [280464]

\$214.88 ea.



Intermatic ET1725C 7-Day 2-Circuit Electronic Control, 120-277 VAC, 60 HZ, 2-SPST, Indoor Metal Enclosure [309629]





Cable Hooks for Communications Cable

in Plastic and Steel • Stackable for added convenience

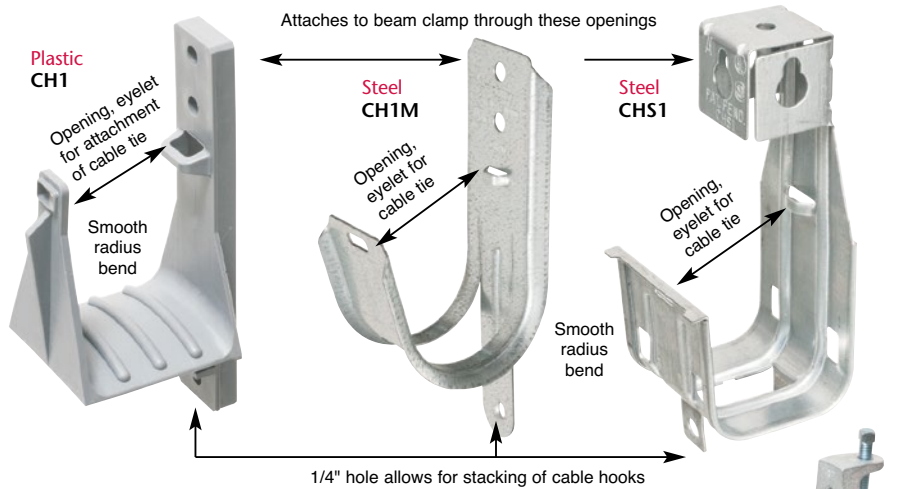

Two Ways to tie down cable

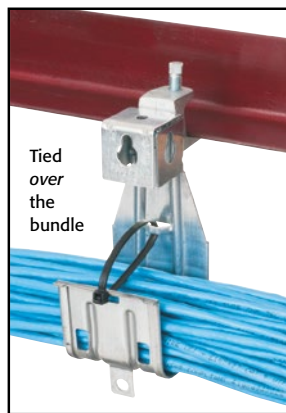
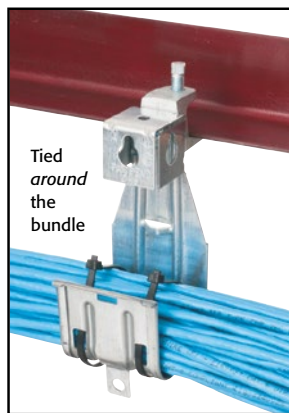

Steel CHS1 Works with Threaded Rod



Stackable for Multiple Cable Tiers... Parallel or Perpendicular Orientation

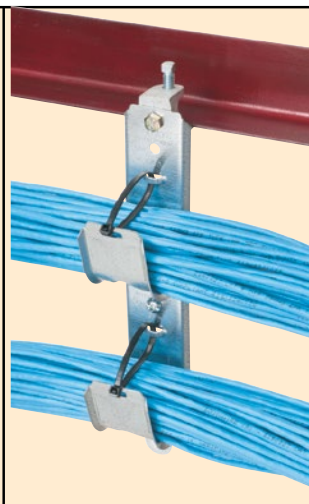
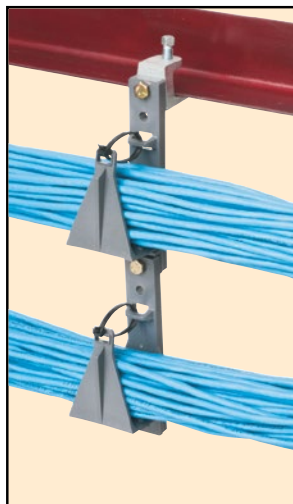

Arlington's Cable Hooks are the super convenient solution for running communications cable.

Available in heavy duty **Plastic** and **two styles in Steel**, these cable hooks have features that can handle any condition encountered on the job.

- 25 lb Support Rating
- Listed for use in air handling spaces per NEC 300.22 (c)
- Supports up to 90 Cat 5e cables with the center radius of the bundle spread over the 2" opening
- Maintains integrity of high performance data cable
- Stackable - in parallel or perpendicular orientation for vertical support of multiple tiers of cable
- Easy to attach to various supports, beam clamps and strut – usable on large panels to ensure proper bend radius

Non-corrosive **plastic CH1**...

- Listed for flexible metal or flexible non-metallic conduit (up to 1-1/4" trade size)

Catalog Number	UPC/DEI/NAED Mfg. #018997	Description	Unit/Std Plg
CH1	10950	Plastic cable hook	50
CH1M	72172	Steel cable hook	50
CHS1	72260	Steel cable hook with multi-directional mounting means	25

Patent pending



Arlington®



NEW!! Arlington ARL CHS1 [398757]

Made in USA

0320/25M © 2020 Arlington Industries, Inc.



SMARTBUYS

Pricing valid March 1 - April 30, 2021



\$90.00 ea.  4013

Louisville FS1506 6' Fiberglass Step Ladder, Type Ia, 300-Pound Load Capacity [4013]

\$130.00 ea.  18874

Louisville FS1508 8' Fiberglass Step Ladder, Type Ia, 300-Pound Load Capacity [18874]

This Louisville 8 foot non-conductive fiberglass step ladder has a load capacity of 300lbs, rated ANSI Type IA. This ladder is equipped with the new and innovative Raptor Top with magnet and multiple tool slots, SHOX impact absorption system, new Raptor boots with non-marring bonded tread mechanically fastened to the upper boot to create a secure slip-resistant footing, inside spreader braces, wide back braces, and double-rivet step construction. The Louisville FS1508 step ladder meets or exceeds the safety standards set by ANSI and OSHA.



 920345

\$130.99 ea.

Louisville FXP1704 4' Fiberglass Pinnacle Pro Platform Platform Ladder [920345]

 920347

\$169.99 ea.

Louisville FXP1706 6' Fiberglass Pinnacle Pro Platform Platform Ladder [920347]

 920348

\$212.99 ea.

Louisville FXP1708 8' Fiberglass Pinnacle Pro Platform Platform Ladder [920348]

Not all products available at all locations. Please speak to your Capital Electric Sales Representative for more information. Capital Electric is not responsible for misprints or typos. Prices are subject to change without notice.

NEW PRODUCTS!



NEW!! Ideal 47-100 Armourband Insulating Wraps, Bag of 10 [1535682]

NEW!! Ideal 47-100J Armourband Insulating Wraps, Jar of 100 [1535499]

Reusable

- Clean, reusable solution to traditional electrical tape application

Quick

- 2X faster installation than electrical tape
- Thickness is equivalent to 6 wraps of premium electrical tape
- 33% wider than standard electrical tape
- Non-slip finish and exceptional elongation for easy installation

Durable

- Improved performance for extreme temperatures
- Decreases risk of stray strands causing electrical shock
- Exceeds flame retardant properties of electrical tape
- Superior silicone construction for improved coverage



NEW!! Ideal 46-050 Quick Snap Snap-In Connector, 1/2", 50/Jar [1594189]

NEW!! Ideal 46-125 Quick Snap Snap-In Connector, 1/2", 125/Jar [1594636]

The IDEAL® Quick Snap connector provides exceptional performance and incredible value. Quick Snap can be installed quickly and easily, without the use of tools, securing cable in place and providing superior protection from damage that can be caused by rough knock-out edges.

Simply push in - no tools required.

- Protects and secures cable
- Snap connector into 1/2" knockout
- Insert from the outside
- Push non-metallic sheathed cable through connector

SMART BUYS

Pricing valid March 1 - April 30, 2021



WHEN THE GOING GETS TOUGH THE TOUGH GET **INNOVATIVE DIGITAL PROS** CAPITAL ELECTRIC



STILL RUNNING

During times like these, you need professionals you can count on. As an essential worker, you are getting tougher, adapting and keeping things up and running like a pro, and so are we.

ADAPTING FASTER

We rolled out Curbside Delivery at all branches so you don't have to leave your vehicle. We created Contactless Delivery Signature, where you sign for your materials on your own device - no physical touch required. We are video conferencing and adding more Virtual Events.

ALWAYS INVESTING

We are investing in inventory of your critical items. While many businesses are slowing down, we are well prepared for challenges and are delivering to jobsites. We are the best pros in the business.

LEADING THE WAY

- Upgrades to online stores and digital capabilities
- Customer service is here to support you in the office or from home
- Warehouses are fully staffed on rotating shifts with temperature testing protocols
- Truck drivers are still making all deliveries

PROS LIKE YOU NEED PROS LIKE US



PROS NEED PROS

WE PROTECT



We protect the most hazardous environments

For product solutions that span virtually every aspect of safety and security, turn to Federal Signal. You'll discover the world's most extensive product line of hazardous location, explosion-proof and safe area products designed to meet or exceed UL, ATEX, IECEx and other global certifications.



\$19.89 ea.



BRK 9120LBL First Alert Hardwired Ionization Smoke Alarm - 10 Year Lithium Battery Backup with Locked Battery Drawer [1019321]

The BRK Brands, Inc. catalog no. 9120LBL (model 9120B) is a wire-in, 120V AC 60Hz single and/or multiple station smoke alarms specifically designed for residential and institutional applications including sleeping rooms of hospitals, hotels, motels, dormitories and other multi-family dwellings as defined in standard NFPA 101. The 9120LBL complies with UL217, CSFM, NFPA 72, HUD, FHA and other agencies that model their codes after the above agencies. They meet building codes where AC/DC with Silence smoke alarms are required. The alarms are interconnectable with up to 18 devices, of which 12 can be smoke alarms.



\$39.49 ea.



BRK SC9120LBL First Alert 120V AC/DC Smoke and CO Alarm - 10 Year Lithium Battery Backup with Locked Battery Drawer [1019322]

120V AC/DC Ionization Smoke/CO Alarm with a 10YR Lithium Battery Back-up. The battery drawer is shipped pre-locked so battery will not be discarded prematurely. Under normal conditions you should not have to replace the battery for the life of the alarm.

Easy Installation/Maintenance - Preferred features include a large opening in the mounting bracket for easy access to wiring. Keyhole slots in the mounting bracket eliminate the need to remove the electrical box screws for installation. A battery pull tab keeps the battery fresh until the home is occupied. Battery installation and removal can occur while the unit is mounted to the ceiling or wall via the side load battery compartment. Two locking features are provided to prevent battery theft and/or theft of the unit. Connection to AC power is made with a "Quick-Connect" wiring harness. Installation is quick, easy and cost effective.

INSTALL IT

DONE

10
YEAR
10



10-Year
Battery



10-Year
Sensor



10-Year
Warranty

BRK[®]

THE PROFESSIONAL STANDARD

TRUSTED, RELIABLE PROTECTION SINCE 1958

See your Capital Electric Sales
Representative for more information.



1019321 Mfg# 9120LBL
Hardwired Ionization
Smoke Alarm with 10-Year
Battery Backup

1019322 Mfg# SC9120LBL
Hardwired Ionization Smoke
& CO Combination Alarm with
10-Year Battery Backup

BRK Brands, Inc. All rights reserved. © 2019 by BRK Brands, Inc. A subsidiary of Newell Brands Inc. (NASDAQ: NWL).
Aurora, Illinois 61804. BRK Brands, Inc. is a subsidiary of Newell Brands Inc. (NASDAQ: NWL).

ANCHORS FOR EVERY JOB



EZ ANCHORS
ONE-PIECE
SELF DRILLING



PAN HEAD
WALL DOG
ANCHORS



WEDGE ANCHORS
FOR CONCRETE
& STONE



LEAD MACHINE
SCREW
ANCHORS



TRUSS HEAD
TOGGLE BOLTS &
WINGS

FOR OVER 125 YEARS MINERALLAC HAS PROVIDED HIGH QUALITY PRODUCTS TO THE ELECTRICAL INDUSTRY

Capital Electric supplies a wide variety of fasteners in various sizes to help you get the job done.

Enquire at your local Capital branch
www.capitalelectricsupply.com
804.588.4867

NEW PRODUCTS!



1637097
NEW!! Fluke IRR1-SOL Solar Irradiance Meter [1637097]

- Measure solar irradiance, ambient and PV module temperature, array orientation and tilt angles
- Make instantaneous measurements to determine the watts per square meter solar irradiation, required by IEC 62446-1 standard
- High contrast LCD with large numbers for easy readability in direct sunlight
- Includes convenient carry case with shoulder strap



1491101
NEW!! Amprobe AT-6010 Advanced Wire Tracer Kit [1491101]

- Work directly on energized circuits without taking equipment offline
- Save time searching for energized and de-energized electrical wires hidden behind walls, ceilings and floors
- Pinpoint wire location with the large LCD receiver screen featuring a two digit readout, bar graph and sound
- Identify breakers and fuses, as well as the location of a break, open or short



1628460
NEW!! Fluke T6-1000PRO/AMER Electrical Tester [1628460]

- Measure voltage to 1000 V AC without test leads
- Simultaneously measure voltage and current
- 17.8 mm open fork is widest in the industry
- Measure up to 200 A on 4/0 wires (120 mm²)



1603268
NEW!! Fluke FLUKE-67-MAX [1603268]

- Clinical infrared thermometer: ± 0.5 °F from 71.6 °F to 109 °F (± 0.3 °C from 22 °C to 43 °C)
- Non-contact thermal scanner device for measurement of human body temperature
- Adjustable alarm visually alerts the user when the temperature exceeds a programmed limit.
- Offers small, lightweight form factor to slip in a coat pocket

SMARTBUYS

Pricing valid March 1 - April 30, 2021





FREE GOODS

DEALS FROM MILWAUKEE

These deals valid until **04/30/21**. Must use eclipse IDs when purchasing.

BUY ONE OF THESE



1638476
 Milwaukee 2551-20-PROMO-KIT
M12 FUEL™ SURGE™
1/4" Hex Hydraulic Driver
Bare Tool [1638476]



1638521
 Milwaukee 2503-20-PROMO-KIT
M12 FUEL™ 1/2" Drill Driver
(Tool Only) [1638521]



1638527
 Milwaukee 2505-20-PROMO-KIT
M12 FUEL™ Installation Drill/
Driver [1638527]



1638906
 Milwaukee 2466-20-
PROMO-KIT M12 FUEL™
1/2" Digital Torque Wrench
with ONE-KEY™ [1638906]



1638906
 Milwaukee 2522-20-PROMO-KIT
M12 FUEL™ 3" Compact Cut Off
Tool [1638907]

Get this FREE!



Milwaukee 48-11-2440 M12™
REDLITHIUM™ XC 4.0 Extended
Capacity Battery Pack



1638908
 Milwaukee 2520-20-
PROMO-KIT M12 FUEL™
HACKZALL® Recip Saw
(Tool Only) [1638908]



1638909
 Milwaukee 0960-20-
PROMO-KIT M12 FUEL™
1.6 Gallon Wet/Dry Vacuum
[1638909]

SMARTBUYS

Pricing valid March 1 - April 30, 2021



Not all products available at all locations. Please speak to your Capital Electric Sales Representative for more information. Capital Electric is not responsible for misprints or typos. Prices are subject to change without notice.



FREE GOODS

DEALS FROM MILWAUKEE

These deals valid until **04/30/21**. Must use eclipse IDs when purchasing.

BUY ONE OF THESE



1478367
Milwaukee
2722-20-PROMO-KIT M18
FUEL™ SUPER SAWZALL®
Reciprocating Saw
[1478367]



1638931
Milwaukee 2829-20-PROMO-KIT
M18 FUEL™ Compact Band Saw
(Tool Only) [1638931]



1638932
Milwaukee 2982-20-PROMO-KIT
M18 FUEL™ 8" Metal Cutting
Circular Saw [1638932]



1638933
Milwaukee 2712-20-PROMO-KIT
M18 FUEL™ 1" SDS Plus Rotary
Hammer (Tool Only) [1638933]

Get this FREE!



Milwaukee 48-11-1880 M18™
REDLITHIUM HIGH OUTPUT™
XC8.0 Battery

BUY ONE OF THESE



1638914
\$279.00 ea.
Milwaukee 2807-20-PROMO-
KIT M18 FUEL™ HOLE HAWG®
1/2" Right Angle Drill (Tool Only)
[1638914]



1638915
\$279.00 ea.
Milwaukee 2808-20-PROMO-
KIT M18 FUEL™ HOLE HAWG®
Right Angle Drill w/ QUIK-LOK™
(Tool Only) [1638915]

Get this FREE!



Milwaukee 48-11-1865 M18
REDLITHIUM™ HIGH OUTPUT™
XC6.0 Battery Pack

Not all products available at all locations. Please speak to your Capital Electric Sales Representative for more information. Capital Electric is not responsible for misprints or typos. Prices are subject to change without notice.



FREE GOODS

DEALS FROM MILWAUKEE

These deals valid until **04/30/21**. Must use eclipse IDs when purchasing.

BUY ONE OF THESE



1638916
 Milwaukee 2719-20-PROMO-KIT M18 FUEL™ Hackzall® (Tool Only) [1638916]



1638927
 Milwaukee 2821-20-PROMO-KIT M18 FUEL™ SAWZALL® Recip Saw (Tool Only) [1638927]



1638928
 Milwaukee 2836-20-PROMO-KIT M18 FUEL™ Oscillating Multi-Tool [1638928]



1638930
 Milwaukee 2738-20-PROMO-KIT M18 FUEL™ 7" Variable Speed Polisher (Tool Only) [1638930]



1638929
 Milwaukee 0970-20-PROMO-KIT M18 FUEL™ PACKOUT™ 2.5 Gallon Wet/Dry Vacuum [1638929]

Get this FREE!



Milwaukee 48-11-1850 M18™ REDLITHIUM™ XC5.0 Extended Capacity Battery Pack



1638910
 Milwaukee 2803-20-PROMO-KIT M18 FUEL™ 1/2" Drill Driver (Tool Only) [1638910]



1638913
 Milwaukee 2853-20-PROMO-KIT M18 FUEL™ 1/4" Hex Impact Driver (Tool Only) [1638913]



1638912
 Milwaukee 2804-20-PROMO-KIT M18 FUEL™ 1/2" Hammer Drill/Driver (Tool Only) [1638912]

Not all products available at all locations. Please speak to your Capital Electric Sales Representative for more information. Capital Electric is not responsible for misprints or typos. Prices are subject to change without notice.



FREE GOODS

DEALS FROM MILWAUKEE

These deals valid until **04/30/21**. Must use eclipse IDs when purchasing.

BUY THIS



\$229.00 ea.

Milwaukee 2598-22-PROMO-KIT M12 FUEL™ 2-Tool Combo Kit: 1/2" Hammer Drill and 1/4" Hex Impact Driver

INCLUDES:

- (1) M12 FUEL™ 1/2" Hammer Drill (2504-20)
- (1) M12 FUEL™ 1/4" Hex Impact Driver (Tool Only) (2553-20)
- (1) M12™ REDLITHIUM™ CP2.0 Battery (48-11-2420)

Get one of these FREE!



Milwaukee 48-11-2460 M12™ REDLITHIUM™ XC6.0 Battery
[1544459]



Milwaukee 2364-20 M12™ ROVER™ Mounting Flood Light
[1544517]

- (1) M12™ REDLITHIUM™ XC 4.0 Extended Capacity Battery Pack (48-11-2440)
- (2) Belt Clip
- (1) Contractor Bag

BUY THIS



Milwaukee 2505-22-PROMO-KIT M12 FUEL™ Installation Drill/Driver Kit [1470018]

The Milwaukee M12 FUEL Installation Drill/Driver Kit features 4 dedicated solutions, delivering unrivaled access and control with up to 300 in./lbs. of maximum torque. 4 dedicated heads, including a 3/8 in. Chuck, Offset Driver, 1/4 in. Hex and Right Angle, can attach in 16 different positions. This provides users with a 4-in-1 drilling and driving solution that is purposefully

Get one of these FREE!



Milwaukee 48-11-2460 M12™ REDLITHIUM™ XC6.0 Battery
[1478199]



Milwaukee 2364-20 M12™ ROVER™ Mounting Flood Light
[1574392]

designed to reach challenging locations. The compact drill driver features a slim tool profile and an inline grip in the back of the tool that provides ultimate tool control and unrivaled access. The front of the tool is equipped with a magnetic bit holder that securely holds multiple bits, enhancing user productivity.

Not all products available at all locations. Please speak to your Capital Electric Sales Representative for more information. Capital Electric is not responsible for misprints or typos. Prices are subject to change without notice.



FREE GOODS

DEALS FROM MILWAUKEE

These deals valid until **04/30/21**. Must use eclipse IDs when purchasing.

BUY THIS



\$179.00 ea.

Milwaukee 2520-21XC-PROMO-KIT M12 FUEL™ HACKZALL® Recip Saw Kit

The Milwaukee 2520-21XC delivers over 4X more run-time, up to 70% faster cutting, and up to 6X longer tool life than competitive saws. The compact, one-handed design provides superior control and the ability to make cuts in tight spaces.

Get one of these FREE!



1390956



Milwaukee 48-11-2460 M12™ REDLITHIUM™ XC6.0 Battery

[1390956]



1574370



Milwaukee 2364-20 M12™ ROVER™ Mounting Flood Light

[1574370]

Its' light weight design is optimal for overhead cutting applications. The POWERSTATE™ Brushless Motor outperforms all leading competitors with constant power output, yet runs cooler with no wearable components. REDLINK PLUS™ Intelligence ensures optimized performance and protects your investment from overload, overheating, and over-discharge.

BUY THIS



Milwaukee 2429-21XC-PROMO-KIT M12™ Cordless Sub-Compact Band Saw Kit

The M12™ Band Saw provides one-handed power and portability to electricians, maintenance professionals, and other users cutting small diameter materials. The M12™ Band Saw weighs only 6.75 lbs and 12" in length, making it ideal for overhead or one-handed cutting applications. This powerful

Get one of these FREE!



1224114



Milwaukee 48-11-2460 M12™ REDLITHIUM™ XC6.0 Battery

[1224114]



1288704



Milwaukee 2364-20 M12™ ROVER™ Mounting Flood Light

[1288704]

saw can cut through 3/4" EMT in only 3 seconds, and will deliver over 150 cuts per charge with the included M12™ REDLITHIUM™ XC High Capacity battery. With a 1-5/8" x 1-5/8" cut capacity and low vibration, the M12™ Band Saw performs clean cuts on the most common small diameter metal cutting applications.



FREE GOODS

DEALS FROM MILWAUKEE

These deals valid until **04/30/21**. Must use eclipse IDs when purchasing.

BUY ONE OF THESE



Milwaukee-PROMO-KIT 2712-22DE M18 FUEL™ 1" SDS Plus Rotary Hammer W/ DE Kit
[1393146]



Milwaukee 2715-22DE-PROMO-KIT M18 FUEL™ 1-1/8" SDS Plus Rotary Hammer W/ DE Kit
[1390967]

Get this FREE!



Milwaukee 2780-20 M18 FUEL™ 4-1/2" / 5" Grinder, Paddle Switch No-Lock (Tool Only)
The world's first cordless grinder delivers the power of a corded grinder with up to 2X more run time and up to 10X longer motor life.

Get this FREE!



Milwaukee 48-11-1850 M18™ REDLITHIUM™ XC5.0 Extended Capacity Battery Pack



\$149.00 ea.
Milwaukee 2144-20-PROMO-KIT M18™ RADIUS™ Compact Site Light w/ Flood Mode [1638934]



\$149.00 ea.
Milwaukee 2366-20-PROMO-KIT M18™ ROVER™ Dual Power Flood Light [1638935]



\$199.00 ea.
Milwaukee 2131-20-PROMO-KIT M18™ ROCKET™ Dual Power Tower Light
[1478389]



FREE GOODS

DEALS FROM MILWAUKEE

These deals valid until **04/30/21**. Must use eclipse IDs when purchasing.

BUY ONE OF THESE



1638936



Milwaukee 2677-23-PROMO-KIT M18™ FORCE LOGIC™ 6T Knockout Tool 1/2" - 4" Kit [1638936]



1638937



Milwaukee 2676-23-PROMO-KIT M18™ FORCE LOGIC™ 10T Knockout Tool 1/2" - 4" Kit [1638937]

Get this FREE!



Milwaukee 2804-20 M18 FUEL™ 1/2" Hammer Drill/Driver (Tool Only)

BUY ONE OF THESE



1638938



Milwaukee 2779-750C-PROMO-KIT M18™ FORCE LOGIC™ 750 MCM Crimper Kit with EXACT™ #6 - 750 MCM Cu Dies [1638938]



1516160



Milwaukee 2779-750A-PROMO-KIT M18™ FORCE LOGIC™ 750 MCM Crimper Kit with EXACT™ #6 - 750 MCM Al Dies [1516160]

Get this FREE!



Milwaukee 2672-21 M18™ FORCE LOGIC™ CABLE CUTTER KIT



1638939



Milwaukee 2877-22-PROMO-KIT M18™ FORCE LOGIC™ 750 MCM Dieless Crimper [1638939]





\$100 OFF!

Trade-In Deals from Milwaukee

These deals valid until **04/30/21**. Must use eclipse IDs when purchasing.



Milwaukee 2997-22-PROMO-KIT M18 FUEL™ 2-Tool Combo Kit: Hammer Drill/Impact [1336907]



Milwaukee 2998-25-PROMO-KIT M18 FUEL™ 5 Tool Combo Kit [1638940]



Milwaukee 2803-22-PROMO-KIT M18 FUEL™ 1/2" Drill Driver Kit [1390969]



Milwaukee 2853-22-PROMO-KIT M18 FUEL™ 1/4" Hex Impact Driver Kit [1406813]



Milwaukee 2759B-22-PROMO-KIT M18 FUEL™ with ONE-KEY™ 1/2" Compact Impact Wrench w/ Friction Ring Kit [1406826]



Milwaukee 2767-22-PROMO-KIT M18 FUEL™ 1/2" High Torque Impact Wrench with Friction Ring Kit [1330663]



Milwaukee 2996-22-PROMO-KIT M18 FUEL™ 2-Tool Hammer Drill & Impact Driver w/ ONE-KEY™ Combo Kit [1458616]



Milwaukee 2804-22-PROMO-KIT M18™ FUEL 1/2" Hammer Drill Kit [1336915]

Not all products available at all locations. Please speak to your Capital Electric Sales Representative for more information. Capital Electric is not responsible for misprints or typos. Prices are subject to change without notice.



\$9.99 ea.



760319

Milwaukee 48-32-4403 SHOCKWAVE™ Impact Duty Driver Bit Set -18PC [760319]

Milwaukee's Shockwave impact driver bits features Wear Guard Tip™ that delivers increased wear resistance which protects the fit over the life of the bit. The driver bits in this Milwaukee SHOCKWAVE™ bit set has optimized Shockzones for each tip type and length of the driver bit to absorb peak torque and prevent breaking. The impact driver bits are made from Custom Alloy76™ steel, heat treated based on tip type to extend the life of driver bits, providing you with up to 50X life vs. competitive impact driver bits. MILWAUKEE® SHOCKWAVE™ driver bits are built to deliver extreme durability for the most demanding jobsite applications.



\$74.99 ea.



907542

Milwaukee 48-89-9221 Step Drill Bit Set - 3PC [907542]

Milwaukee® Step Drill Bits with JAM-FREE Performance feature a dual-flute design delivering up to 2X faster hole times, up to 4X longer life and up to 50% more holes per battery charge than competitors. Ideal for drilling small and large-diameter holes in steel and plastic, these bits are Optimized for Cordless Drills in High Speed. The Rapid Strike™ tip allows for a fast and accurate start that generates less heat, resulting in longer bit tip life. The Step Drill Bit 3-Piece Set includes bits #1 (48-89-9201), #2 (48-89-9202) and #4 (48-89-9204). Jam-Free Performance in high speed with most professional 18 volt cordless drills with lithium-ion battery technology.



\$99.99 ea.



1339861

Milwaukee 48-89-9257 SHOCKWAVE™ Impact Duty™ ELECTRICAL KIT (#1, #4, #9) [1339861]

Milwaukee's Shockwave Impact Duty step drill bits are made in the USA with global materials and give you best-in-class performance in impact drivers with the versatility to be used in drills. The ¼" hex shank has an optimized SHOCKZONE™ body providing you with the industry's most durable shank, reducing early shank breaks.



\$14.99 ea.



1295052

Milwaukee 49-22-1110 SAWZALL® General Purpose 10pc Blade Set [1295052]

The 10-Piece SAWZALL® Blade Set offers an assortment of wood and metal cutting SAWZALL® blades for a wide range of applications. Milwaukee SAWZALL® Blades feature an optimized tooth design that provide a longer life over standard bi-metal blades and are ideal for fast, flexible cuts. The set also includes an innovative job site durable case for convenient blade storage.



The Smart Choice

The Only Choice

SAVE Time & Money with Kwikon ENT & Fittings compared to traditional EMT

Kwikon Electrical Nonmetallic Tubing (ENT), fittings, slab boxes and accessories are designed to work together and provide the most robust concrete-tight ENT system on the market.



KWIKON ENT

- Color-coded stripes for easy cable identification
- Available in coils, 10' sticks, and reels
- Lightweight and flexible for easy install that reduces labor by up to 50%



KWIKON FITTINGS

- Six locking tabs for unbreakable connections
- Concrete-tight, requiring no solvent welding or tape
- Fire, pull and impact resistant



KWIKON SLAB BOXES

- Boxes are installation ready and concrete-tight
- Approved for support of ceiling fans up to 35 lbs and luminaries up to 50 lbs
- Clear Vue removable cover for marking visibility and prevents slurry or stucco from entering the box



FORM STUBBIES

- Eliminate the need to drill to the deck
- Available in the original stubby design, the angled version and the Multi-Link
- Protects the ENT from potential damage during the removal of wood forms

See your Capital Electric Sales Representative for more information.



Products are manufactured by IPEX Electrical Inc. and distributed in the United States by Kraloy, a division of Multi Fittings Corp. Kraloy is a registered trademark of Multi Fittings Corp. Kwikon® is a trademark of IPEX Branding Inc.

MACTM

B L O C K

Splice & Tap Connectors



- Splice or tap up to 8 conductors
- Variable conductor sizes per port
- Conductor range: 6-18 AWG, 6-14 FLEX
- Connector rated for 90°C, 300 volts
- Insulated cover rated to 105°C
- Certified for power and grounding
- Retrofit aluminum to copper connections
- Widest conductor range in the industry
- Runs on average 35°F cooler than leading twist-on connectors
- Secureness strength 2.5 times higher than that of leading twist-ons

See your Capital Electric Sales Representative for more information.

ILSCO[®]

ALL JACK™

LIFT AND HOLD YOUR WORKPIECE IN PLACE

iTOOLco.



Holds workpiece in place at various angles



One handed gas shock operation

Increase productivity and decrease fatigue using iTOOLco's All Jack™. Install pipe, lights, cabinets, drywall, temporary dust barriers and much more with this innovative jack designed to lift and support the weight of your workpiece while you anchor it into position.

High ceilings and ladder work are not a problem for this dynamic tool. Reach from 58" to a staggering height of 13'6". The industrial gas shock ensures a snug, stable support that stays in place while you complete the installation. Once your workpiece is secured into place, simply remove the All Jack™ by releasing the shock. More powerful than a typical support pole, the All Jack's gas shock can handle your most challenging jobs.



Perfect for overhead & lift work



iTOOLco AJ01 All Jack [1609758]

FASTER SAFER WORKSPACE

6
YEAR
LIMITED
WARRANTY

GEAR PUNCH™

**RATED FOR MILD
AND STAINLESS STEEL**

- iTOOLco's SLICK-CUT™ technology allows 1/2" through 6" punches and dies to cut through an industry leading 10 gauge mild and stainless steel while maintaining the sharpness of the cutting edges
- Gear Punch™ tool will work with any make or model of corded or cordless drill, new or old drills, no special additions needed
- Punches and dies are clearly marked with trade standard conduit sizes as well as Center Point™ marks for perfect alignment, no matter what direction you cut from
- Lightweight and easy to use
- Gear Punch™ tool is compatible with other punch and die offerings
- Lifetime replacement on Draw Studs



**iTOOLco GP01 Gear Punch
w/ Draw Studs Only** [1021445]
****Not in stock. Special Order only****



**iTOOLco GP122 Gear Punch Kit 1/2"
to 2" (Tool Included)** [1025330]



**iTOOLco GP123 Gear Punch Kit 2-1/2"
to 4" (Tool Not Included)** [1025332]



**iTOOLco GP124 Gear Punch Kit 1/2"
to 4" (Tool Included)** [1004436]
Includes GP122, GP123 & GP156



**iTOOLco GP126 Gear Punch Kit
1/2" to 6" (Tool Included)** [1022899]
Includes GP122, GP123 & GP156
****Not in stock. Special Order only****



**iTOOLco GP156 Gear Punch Kit
5" & 6" (Tool Not Included)** [1045879]
****Not in stock. Special Order only****

CANNON 12K™

THE TOUGHEST PULLER YOU'LL EVER USE

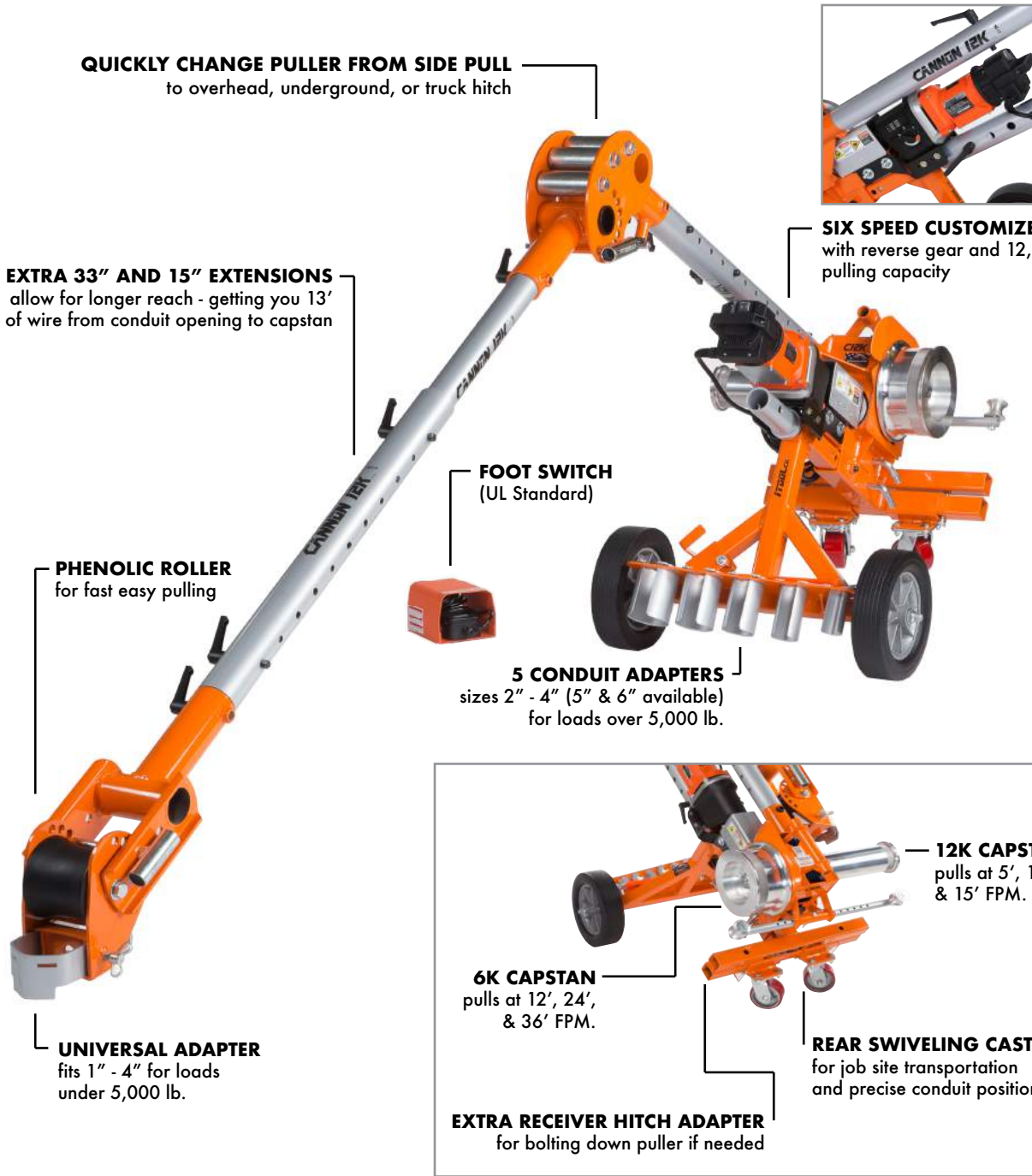

QUICKLY CHANGE PULLER FROM SIDE PULL
to overhead, underground, or truck hitch



SIX SPEED CUSTOMIZED MOTOR
with reverse gear and 12,000 lb.
pulling capacity

EXTRA 33" AND 15" EXTENSIONS
allow for longer reach - getting you 13'
of wire from conduit opening to capstan

FOOT SWITCH
(UL Standard)

PHENOLIC ROLLER
for fast easy pulling

5 CONDUIT ADAPTERS
sizes 2" - 4" (5" & 6" available)
for loads over 5,000 lb.

UNIVERSAL ADAPTER
fits 1" - 4" for loads
under 5,000 lb.

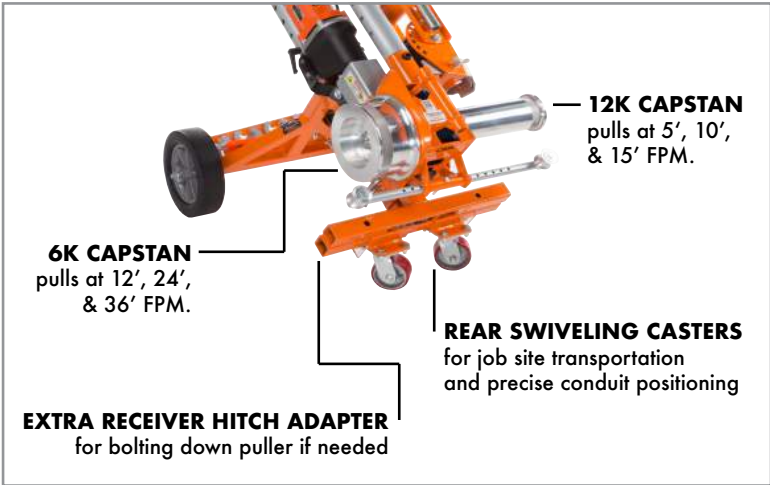

12K CAPSTAN
pulls at 5', 10',
& 15' FPM.

6K CAPSTAN
pulls at 12', 24',
& 36' FPM.

REAR SWIVELING CASTERS
for job site transportation
and precise conduit positioning

EXTRA RECEIVER HITCH ADAPTER
for bolting down puller if needed

Model	Description	Specifications
1282103 iTOOLCo C12K [1282103]	Cannon 12K™	68"L x 30"W x 57"H (Collapsed) 188"L x 30"W x 57"H (Extended) 404 lb.

6
YEAR
LIMITED
WARRANTY

MADE IN THE
USA
WITH GLOBAL
COMPONENTS

*Sold as shown

Patented

Not all products available at all locations. Please speak to your Capital Electric Sales Representative for more information. Capital Electric is not responsible for misprints or typos. Prices are subject to change without notice.

SAFE PULL™ RUNNING LINE TENSION METER

ACCURATELY MONITOR CABLE TENSION &
SET CUSTOM OVERLOAD LIMITS



Overhead & Right Angle Pulls



Underground Pulls

*Phone case shown using Steelie Magnetic Mount

Track every pull on your mobile device with the Safe Pull™ RLT application. Set load limits and get audible alarms on pulls with loads measuring up to 20,000 lbs. The convenient GPS capability ensures correct information is provided about the corresponding jobsite and notifications about tracked loads are sent wherever they need to go via email & stored on your device until you're ready to delete them.

Accurately monitor & save cable tension while preventing damage. Increase safety ensuring that cable is being pulled at a safe tension level by integrating the Safe Pull RLT. The lightweight design & included carrying case allows for easy transportation around the jobsite.



App for Android & IOS Platforms

*RLT shown utilizing hanging method

1633919



iTOOLco SPRLT20K Safe Pull Running Line Tensioner

[1633919] Item not in stock - special order only.

No. 1224 Threading Machine

The RIDGID Model 1224 is the industry standard 4" Threading Machine. Thousands of satisfied customers around the world give testimony of its dependability.

Capacity

Pipe: 1/4" – 4" (6mm – 100mm)

Bolt: 1/4" – 2" (6mm – 50mm)

Benefits

- **Speed:** threads 1/4" – 2" pipe at 36 RPM and 2 1/2" – 4" at 12 RPM.
- **Versatility:** threads black, galvanized and plastic coated pipe, stainless steel, IMC, heavy-wall conduit, and rod up to RC 30.
- **Quiet Operation:** an induction motor insures sound levels well within the limits set by OSHA.
- **Low Voltage Operation:** special start/run capacitors allow operation in less than ideal conditions.



Technical Specifications

Motor: 1 1/2 HP, single phase, 60 Hz, or 50 Hz, induction type.

Motor Control: REVERSE/OFF/FORWARD, heavy duty rotary switch with integral foot switch.

Spindle Speed: 36 – 12 RPM, right hand, left hand.

Gear Box: Two speed gear box 3:1 ratio.

Standard Equipment

Model 1224 Threading Machine with foot switch

1 – No. 714 (914) 2 1/2" – 4" Receding Self-Opening Die Head

1 – No. 711 (911) 1/4" – 2" Universal Self-Opening Die Head

1 – No. 764 Cutter

1 – No. 744 Reamer

3 – Sets of Dies (1/2" – 4")

1 – Gallon Premium Oil

1 – F229 Spare Wheel

1 – No. 744 Cutter; No. 764 Cutter

3 – Hex Keys; 1 3/4" Combination Wrench

1 – Tool box



Ridgid 26092 Model 1224 Pipe Threading Machine, 36/12 RPM Pipe Threading Machine with Hammer Chuck, 1/2-Inch to 4-Inch Pipe Dies and NPT Threading Die Head
[204135] Item not in stock - special order only.

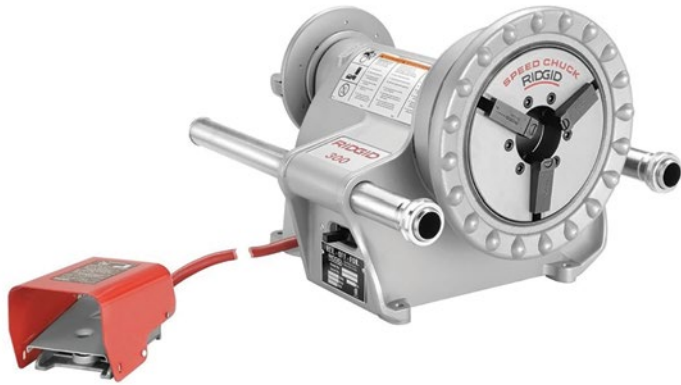

Ridgid 41855 Model 300 Power Drive

[985263] Item not in stock - special order only.

Features:

- RIDGID® speed chuck.
- Reversible 1/2 HP universal motor.
- Recessed On/Off/Reverse switch.
- Convert a 300 Power Drive to a portable threading machine.
- Ideal for use with RIDGID roll groovers.



Ridgid 67182 Model 300 Compact Threading Machine [979428] Item not in stock - special order only.



Ridgid 36273 (460-6) Portable Tristand Vise

[1080619] Item not in stock - special order only.

The TRISTAND pipe vise features integral folding legs for easy transport and setup, tool hangers and a base which overhangs the front legs for clear tool swing.



Ridgid 44473 SR-24 Line Locator with Bluetooth® and GPS [1453295] Item not in stock - special order only.



Ridgid 19238 NaviTrack Scout® Locator [726369] Item not in stock - special order only.

SMART BUYS

Pricing valid March 1 - April 30, 2021



NEW PRODUCTS!



Greenlee LS100X11SB4 (52084935) Intellipunch Knockout System (formerly 52079417) [1141639]

- (1) Intelli-PUNCH™ 11-Ton Tr
- 1/2" to 4" Conduit SlugBuster Punches and Dies
- (1) 3/8" Draw Stud
- (1) 3/4" Draw Stud
- (1) 1-1/8" Sleeve Adapter
- (3) Spacers
- (2) 18V 3.0Ah Li-Ion Batteries
- (1) 120 VAC Charger
- (1) Carrying Case



NEW!! Greenlee FTXF-100 (52087565)

100' Fish Tape [1579164]

- Free-spinning interior reel for faster fishing
- Utilize secondary exit and set case on the ground to free-up both hands for fishing
- Anti-Bind Design
- Quick-Change replacement reels
- Fatigue/Strain reducing ergonomic case design
- Bulk Pack Available (Qty: 3) - FTXF-100BP
- Compatible Replacement Reels: RFTXF-50, RFTXF-100



NEW!! Greenlee GSBSET3 Step Bit Set #1 #4 #9 [1637622]

- Durable split-point tip for fast, accurate material penetration.
- Patented split-step design optimizes chip load for fast, smooth cutting, and more holes per charge.
- Progressive cutting edges provide balanced aggression to maximize torque efficiency and minimize stalling.
- Improved double flute design for superior chip evacuation, cutting speeds and tool life.
- Three-flat shank for all 1/2" drill chucks.
- Laser markings for quick, easy product and size identification.
- Replaced 35884



NEW!! Greenlee FTXF-50 (52087564) 50'

Fish Tape [1617628]

SMARTBUYS

Pricing valid March 1 - April 30, 2021



398373



Greenlee CS-8000 (50121260) Circuit Seeker

[398373] Item not in stock - special order only.

- Advanced patented non-directional sensing technology
- Superior sensitivity and functionality providing for accurate tracing & locating
- Ergonomic receiver with information-rich full-color graphical LCD
- Graphics and audible signal provide quick and easy way to understand tracing feedback
- Traces concealed wiring, locates junction boxes, and finds breakers for live or open circuits
- Locates and identifies blown fuses
- Finds shorts and breaks in conductors
- Low pitch, high volume audible indicator
- User-selectable automatic or manual gain capability for fast, convenient use
- Can be used on GFCI protected circuits
- Automatic backlight on receiver maximizes battery life
- Supports transmitter-to-receiver distances up to 4 miles for closed circuit tracing
- Lifetime Limited Warranty



NEW PRODUCTS!



1519850



NEW!! Greenlee GLSS980KIT-B Shear 30T Shearing Station (with 980 Electric Hydraulic Pump) [1519850]

- Hydraulically Powered - Includes Greenlee 980 Electric Hydraulic Pump
- Powerful 30-Ton Ram - Easily and quickly shears through tough material
- Laser-Marked Measuring System - Accurately shear each piece to precise length with movable arm and measuring stop
- Quick Die Change System - Easily swap out dies with no tools or loose parts
- Automatic Retraction - Retaining spring arm brings back dies into starting position for next cut
- Material Rest - Keeps material perpendicular for clean cuts and extended die life
- Hydraulic Hose Through-Hole - Safely contains hydraulic hose from the pump to the ram

SMART BUYS

Pricing valid March 1 - April 30, 2021





G6 TURBO™ 6,000 lb Puller

HANDS DOWN FASTER. PERIOD.



1210379



Greenlee G6 (52080715) G6 TURBO™ 6000 LB Cable Puller [1210379] Item not in stock - special order only.

- Setup in less than 60 seconds
- No loose pieces, allowing quick changeover for easy transport
- No adapter needed, easily clamp to conduit in seconds
- Dual capstans increase pulling speeds and maximize efficiency
- Two speed motor specially designed for 6,000 pound pulls
- Circuit breaker monitor for safe auto shutoff and extend motor life
- Force indicator prevents damage to puller
- Build in dolly for fast easy transport
- Ergonomic design eliminates heavy lifting during setup
- Right-angle sheave allows the operator to stand out of the direct line of force

Not all products available at all locations. Please speak to your Capital Electric Sales Representative for more information. Capital Electric is not responsible for misprints or typos. Prices are subject to change without notice.

NEW TOOLS GREENLEE GATOR INSULATED CRIMPERS AND CUTTERS

-not in stock - special order only-

NEW PRODUCTS!

NEW!! FIRST OF THEIR KIND INSULATED CRIMPERS AND CUTTERS

The new Greenlee Gator Insulated Series battery-powered hydraulic cutting and crimping tools feature a patent-pending design to help protect operators from electrical shock up to 1000V

The Tri-Insulation Barrier impedes voltage from discharging between the tool head and tool body.

Each tool undergoes dielectric testing as part of our production process to assure voltage protection up to 1000V.

Brush guarded heads, which aid in avoiding accidental contact with conductors.

Insulated Crimping Tools:

EK6IDCVX – 6-Ton In-Line Indenter • EK622CVX – 6-Ton In-Line Crimper • EK628VX – 6-Ton In-Line Crimper • EK425VX – 6-Ton In-Line Crimper

Insulated Cutting Tools: • ESC50HVX – In-Line Cable Cutter • ESC35HVX – In-Line Cable Cutter • ES32HVX – In-Line Cable Cutter • ESC25HVX – In-Line ACSR Cutter • ES20HVX – In-Line ACSR Cutter



1556508
EK425VXD011
Crimper, 6T V,
CJD30 120V
[1556508]



1556511
EK425VXK11
Crimper 6T V,
CJK, 120V
[1556511]



1556515
EK6IDCVX11
Crimper 6T V,
6ID, 120V (PVC)
[1556515]



1550969
EK628VX11
Crimper 6T
V, CJ22 120V
[1550969]



1556516
ES32HVX11 Cutter
V, 32MM,
(PVC)
[1556516]



1556517
ESC35HVX11
Cutter, V, 35MM,
120V (PVC)
[1556517]



1556518
ESC50HVX11
Cutter, V, 50MM,
120V (PVC)
[1556518]



Greenlee G1 Cordless G1 Versi-Tugger™ Handheld 1000 LB Puller

[1500842] Item not in stock - special order only.

- Handheld, Cordless Puller
- Constant pull force up to 600 lbs
- Unload Poly Line In Seconds After A Pull - Line slides off tapered capstan when spool wall is removed, no need to reverse the drill
- Pull 68% faster than manual pulling
- Works most 18v-20v cordless drills
- Adjustable boom - The 17" rotatable boom quickly adjusts to fit each job with 3 length positions to choose from. Extend the boom with 1" rigid conduit
- Universal Pulling Head - One-size-fits-all pulling head attaches quickly to any size conduit from 1/2" - 4"

NEW PRODUCTS!



1584769

\$59.97 ea.

NEW!! Klein Tools CL220 Digital Clamp Meter, AC Auto-Ranging 400 Amp with Temp [1584769]

Measures AC current and NCVT via clamp and AC/DC voltage, resistance, and continuity via test-leads, and temperature with thermocouple.



1595297

\$59.99 ea.

NEW!! Klein Tools 60406RL Hard Hat, Non-Vented, Full Brim with Rechargeable Headlamp [1595297]

Safety hard hat has patent-pending accessory mounts on front and back, breathable, unique suspension system, one-handed adjustment with large knob ratchet mechanism.



1635699

\$42.00 ea.

NEW!! Klein Tools 832-26 Lineman Claw Hammer [1635699]

Hammer has large head, lighter 26-Ounce head, milled face, claw end, fiberglass handle with textured grip.



1607778

\$34.97 ea.

NEW!! Klein Tools 63225 High-Leverage Cable Cutter [1607778]

Cable cutter, high-leverage design, precision, one-hand shearing action, cable-gripping shear-type jaws, beveled jaw tips jaw, through-hardened, hot-riveted joint, plastic dipped handles, forged, custom, US-made tool steel.



1590872

\$69.99 ea.

NEW!! Klein Tools 60146 Safety Helmet, Non-Vented-Class E, with Rechargeable Headlamp, White [1590872]

Compact, lightweight safety helmet design for at-height and confined space applications, safety hard hat has patent-pending accessory mounts on front and back, breathable, 6-point suspension along with chin strap.



1595474

\$39.99 ea.

NEW!! Klein Tools VISORCLR Detachable Half Face Visor Clear [1595474]

High Quality Visor, low Profile: half-face, wrap-around design, superior Impact Protection, anti-fog, scratch resistant, UV Protection.

KLEIN TOOLS®



SMARTBUYS

Pricing valid March 1 - April 30, 2021

 **Capital Electric**
A Sonepar Company



1597356

\$21.99 ea.

NEW!! Klein Tools 60173 Safety Glass [1597356]

Safety glasses provide enhanced coverage, superior impact protection, scratch resistant lens, anti-fog feature, UV Protection.

KLEIN TOOLS®



\$29.97 ea.

Klein Tools 32717 All-In-1 Precision Screwdriver Set with Case [1600177]

\$19.97 ea.



Klein Tools 32500MAG 11-in-1 Magnetic Screwdriver / Nut Driver [1579062]

Integrated screwdriver / nut driver magnetic barrel holds 8 popular tips and converts to 3 nut driver sizes.

\$24.97 ea.



Klein Tools 32307 27-IN-1 Tamperproof Screwdriver [1598904]

\$19.97 ea.



Klein Tools 32305 15-IN-1 Ratcheting Screwdriver [1598903]

Klein Tools' Multi-Bit Screwdrivers help make your job a little easier. The 15-in-1 Ratcheting Screwdriver's durable ratcheting mechanism allows for faster and easier all-day driving.

\$14.97 ea.



Klein Tools 32308 8-IN-1 Adjustable Length Stubby Driver [1598905]

Klein Tools' Adjustable Length Screwdrivers function both as multi-bit screwdrivers and impact driver attachments.

\$14.97 ea.



Klein Tools 32314 14-IN-1 Precision Screwdriver/ Nut Driver [1598901]

\$19.97 ea.



Klein Tools 32303 14-IN-1 Adjustable Length Screwdriver [1598902]

Klein Tools' Adjustable Length Screwdrivers function both as multi-bit screwdrivers and impact driver attachments.



\$99.99 ea.

Klein Tools 94130 1000V Insulated Tool Kit, 5-Piece [1579061]

5-Piece kit includes essential 1000V rated insulated tools including pliers (2), wire stripper and screwdrivers (2).



\$89.97 ea.

Klein Tools 55421BP-14 Tradesman Pro Organizer Backpack [945359]



SMART BUYS

Pricing valid March 1 - April 30, 2021



\$61.78 ea. ⁷⁹⁴⁹⁰

Marley 2516W 120V 1500W 6FT Residential Baseboard Heater [79490]

- Convection heats the room rapidly, without uneven hot and cold zones, providing comfort from floor to ceiling.
- Heat your space without kicking up dust or other allergens. The natural convection airflow doesn't rely on a blower or fan to move warm air throughout the room.
- Wire up and connect this baseboard quickly and easily with its large wiring compartment, dual knockouts and built-in cable clamp.
- For maximum efficiency, the unit converts all incoming electric energy into heat, according to Department of Energy standards.
- For worry-free warmth, these UL Listed baseboard heaters offer an overheat protection feature that prevents the unit from running when its air intake is blocked.



\$43.95 ea. ¹⁰⁰²⁷⁸

Marley 2574W 277/240/208V 1000/752/564W 4FT Residential Baseboard Heater [100278]

For quiet, comfortable heating, choose these baseboard heaters. These fan-free heating units deliver warmth and comfort in a low-profile housing that's safe to install on the wall or directly on carpet, tile or other flooring.

\$281.99 ea. ²⁴³⁸⁸⁸

Marley QPH4A Portable Unit Heater [243888]

When the temperature drops, bring in some extra warmth with a heavy-duty portable heater. With the option to go freestanding or mount it on the wall or ceiling, it fits perfectly in your garage, workshop or jobsite.

- Two heat settings: 9,100 BTUs (2,667 Watts), 13,650 BTUs (4,000 Watts)
- Permanently lubricated, unit-bearing fan motor
- Three-way bracket lets you position unit on floor or other flat surface, or mount to ceiling or wall
- Adjustable thermostat to maintain heating comfort levels
- Compact and easy to carry with built-in handles
- 6 ft. cord included





\$81.33 ea. 961888 

Marley CZ1512T 1500W 120V Compact Wall Heater [961888]

For true zonal heating in a compact design that fits in anywhere, choose QMARK wall heater CZ1512T. Its fast-response heating element kicks in quickly, providing warmth for your bedroom, bathroom or hallway. The patented clip-n-fit system, thermal fuse and self-hold limit makes installing it on the wall safe and easy.



\$361.17 ea. 94495 

Marley MUH0381 208V 3000W Unit Heater [94495]

This rugged unit heater works well in industrial settings. Install it in factories, warehouses, garages, stairwells, power stations or mechanical rooms. Its powerful output capacity even makes it suitable for heating your loading dock or other indoor/outdoor transition spaces.



\$399.43 ea. 1017332 

Marley AWH4404F 240V 4000/2000W Heavy-Duty Wall Heater [1017332]

QMark / Marley high-capacity, heavy-duty fan forced wall heaters are designed for use almost anywhere in commercial or industrial areas requiring high capacity and quick recovery. They perform exceptionally well in such applications as commercial buildings, entryways, hotels, offices, restaurants and stores.



Capital Electric

A Sonepar Company

Capital Electric provides electrical products, lighting, and services to contractors, builders, and end-users in the Mid-Atlantic and Southeastern regions. We serve customers in the District of Columbia, Maryland, Virginia, Delaware, Pennsylvania, West Virginia, North Carolina, South Carolina, and Georgia from over 70 locations and from our 220,000 square foot headquarters and central distribution center in Upper Marlboro, MD. Our mission is to be The Electrical Distributor of Choice for our customers, our employees, and our suppliers.

PENNSYLVANIA

Chambersburg	420 W. Commerce St, Chambersburg, PA 17201	(717) 264-4631
Gettysburg	1660 Biglerville Rd, Gettysburg, PA 17325	(717) 334-6721
Hanover	100 Kindig Ln, Ste 4, Hanover, PA 17331	(717) 632-7773
Lancaster	1812 Olde Homestead Ln, Ste A, Lancaster, PA 17601	(717) 394-6881
McConnellsburg*	22438 Great Cove Rd, McConnellsburg, PA 17233	(717) 987-0183
Mechanicsburg	4700 Westport Dr, Mechanicsburg, PA 17055	(717) 766-3287
York	1150 N. Sherman St, York, PA 17402	(717) 755-1455

MARYLAND

Annapolis	1816 George Ave, Annapolis, MD 21401	(410) 919-2400
Baltimore	600 W. Hamburg St, Baltimore, MD 21230	(410) 752-4080
Beltsville	10417-B Baltimore Ave, Beltsville, MD 20705	(301) 837-5000
Chestertown	305 N. College Ave, Chestertown, MD 21620	(410) 778-1154
Columbia	9570 Berger Rd, Columbia, MD 21046	(410) 995-6844
Cumberland	86 Wineow St, Cumberland, MD 21502	(301) 777-0060
Frederick	270 Interstate Cir, Ste 200, Frederick, MD 21704	(301) 663-1232
Gaithersburg	15886 Gaither Dr, Ste A, Gaithersburg, MD 20877	(301) 921-4446
Glen Burnie	175 Penrod Ct, Ste Q-S, Glen Burnie, MD 21061	(410) 761-2870
Golden Ring	6903 Golden Ring Rd, Rosedale, MD 21237	(410) 918-0540
Hagerstown (Cross Dock)	12101 Insurance Way, Hagerstown, MD 21740	(301) 302-8575
Hagerstown (Counter)	12111 Insurance Way, Hagerstown, MD 21740	(301) 302-8409
Havre de Grace	1846 Pulaski Hwy, Havre de Grace, MD 21078	(410) 939-5880
Ocean Pines	11070 Cathell Rd, Ste 25, Berlin, MD 21811	(410) 208-0800
Salisbury	1774 Westwood Dr, Salisbury, MD 21801	(410) 546-1221
Timonium	14 W. Aylesbury Rd, Lutherville-Timonium, MD 21093	(410) 252-7020
Upper Marlboro (Office)	8511 Pepco Pl, Upper Marlboro, MD 20772	(301) 909-6500
Upper Marlboro (Counter)	8511 Pepco Pl, Upper Marlboro, MD 20772	(301) 909-6550
Westminster	1101-A Business Pkwy S, Westminster, MD 21157	(410) 848-3050
White Plains	4382 Crain Hwy, White Plains, MD 20695	(301) 885-3232

VIRGINIA

Alexandria	5701 General Washington Dr, Ste A-B, Alexandria, VA 22312	(703) 253-9780
Ashland	11052 Air Park Rd, Ashland, VA 23005	(804) 752-6124
Blacksburg	2901 Prosperity Rd, Ste A, Blacksburg, VA 24060	(540) 953-4590
Charlottesville	2100 Berkmar Dr, Charlottesville, VA 22901	(434) 977-2990
Charlottesville	2390 Hunters Way, Charlottesville, VA 22911	(434) 293-8117
Chesapeake	1122 Executive Blvd, Ste B, Chesapeake, VA 23320	(757) 547-7222
Colonial Heights	1104 W. Roslyn Rd, Colonial Heights, VA 23834	(804) 431-3929
Fairfax	2808 Merrilee Dr, Ste A, Fairfax, VA 22031	(703) 485-8960
Fishersville	1688 Jefferson Hwy, Ste 102, Fishersville, VA 22939	(540) 946-7950
Fredericksburg	11001 Houser Dr, Ste 18, Fredericksburg, VA 22408	(540) 710-7200
Goochland	12925 Plaza Dr, Richmond, VA 23233	(804) 476-3095
Harrisonburg	1602 S. High St, Harrisonburg, VA 22801	(540) 433-8200
Manassas	7203 Gateway Ct, Manassas, VA 20109	(703) 361-6028

Midlothian	2931 Oak Lake Blvd, Midlothian, VA 23112	(804) 588-4866
Newport News	1030 48th St, Newport News, VA 23607	(757) 244-0125
Oyster Point	813 Diligence Dr, Ste 125, Newport News, VA 23606	(757) 327-7914
Richmond	801 Johnston Willis Dr, Richmond, VA 23236	(804) 379-7770
Richmond	1901 N. Hamilton St, Richmond, VA 23230	(804) 355-8003
Roanoke	811-B Connecticut Ave NE, Roanoke, VA 24012	(540) 283-5353
Sterling	45969 Nokes Blvd, Ste 155, Sterling, VA 20166	(703) 444-5080
Virginia Beach	2561 Horse Pasture Rd, Ste 102, Virginia Beach, VA 23453	(757) 821-7733
Virginia Beach	5894 Thurston Ave, Virginia Beach, VA 23455	(757) 460-1161
Williamsburg	1637 Merrimac Trl, Williamsburg, VA 23185	(757) 253-1440
Winchester	2740 S. Pleasant Valley Rd, Winchester, VA 22601	(540) 662-1769
Woodbridge	3320 Noble Pond Way, Ste 106, Woodbridge, VA 22193	(703) 586-9590

WEST VIRGINIA

Martinsburg	48 Brian Dr, Martinsburg, WV 25405	(304) 263-1212
-------------	------------------------------------	----------------

NORTH CAROLINA

Charlotte	1407-C Westinghouse Blvd, Charlotte, NC 28273	(704) 588-6878
Durham	4001 Stirrup Creek Dr, Ste 600, Durham, NC 27703	(919) 384-7093
Fayetteville	334 E. Mountain Dr, Fayetteville, NC 28306	(910) 323-0303
Gastonia	1434 Castle Ct, Gastonia, NC 28052	(704) 866-6000
Greensboro	407-A Pomona Dr, Greensboro, NC 27407	(336) 294-3257
Hickory	222 22nd St SW, Hickory, NC 28602	(828) 328-2295
Raleigh	2539 Noblin Rd, Ste 107, Raleigh, NC 27604	(919) 876-3650

SOUTH CAROLINA

Anderson	615 McGee Rd, Anderson, SC 29625	(864) 932-4126
Bluffton (Hilton Head)	23 Simmonsville Rd, Bluffton, SC 29910	(843) 706-1600
Charleston	4801-A Rivers Ave, Charleston, SC 29406	(843) 745-6900
Columbia	900 Sunset Blvd, West Columbia, SC 29169	(803) 739-6000
Moncks Corner	502 E. Main St, Moncks Corner, SC 29461	(843) 761-6627
Myrtle Beach	3908 Wesley St, Myrtle Beach, SC 29579	(843) 236-8603

GEORGIA

Augusta	806 Trane Rd, Augusta, GA 30909	(706) 736-7021
Savannah (Pooler)	83 Columbia Dr, Pooler, GA 31322	(912) 964-3013



ENSCO LOCATIONS

Charlotte	4400 South Tryon St, Charlotte, NC 28217	(704) 529-1523
Greensboro	407-A Pomona Dr, Greensboro, NC 27407	(336) 292-9000
Raleigh	2539 Noblin Rd, Ste 106, Raleigh, NC 27604	(919) 231-4040

Capital Electric (formerly CapitalTristate / Eck Supply) Location Map

Capital Electric Counter Locations

Pennsylvania

1. Chambersburg
2. Gettysburg
3. Hanover
4. Lancaster
5. McConnellsburg*
6. Mechanicsburg
7. York

Maryland

8. Annapolis
9. Baltimore
10. Beltsville
11. Chestertown
12. Columbia
13. Cumberland
14. Frederick
15. Gaithersburg
16. Glen Burnie
17. Golden Ring
18. Hagerstown
19. Havre de Grace
20. Ocean Pines
21. Salisbury
22. Timonium
23. Upper Marlboro
24. Westminster
25. White Plains

Virginia

26. Alexandria
27. Ashland
28. Blacksburg
29. Charlottesville
30. Charlottesville
31. Chesapeake
32. Colonial Heights
33. Fairfax
34. Fishersville
35. Fredericksburg
36. Goochland

Virginia Cont'd

37. Harrisonburg
38. Manassas
39. Midlothian
40. Newport News
41. Oyster Point
42. Richmond
43. Richmond
44. Roanoke
45. Sterling
46. Virginia Beach
47. Virginia Beach
48. Williamsburg
49. Winchester
50. Woodbridge

West Virginia

51. Martinsburg

North Carolina

52. Charlotte
53. Durham
54. Fayetteville
55. Greensboro
56. Hickory
57. Gastonia
58. Raleigh

South Carolina

59. Anderson
60. Bluffton (Hilton Head)
61. Charleston
62. Columbia
63. Moncks Corner
64. Myrtle Beach

Georgia

65. Augusta
66. Savannah

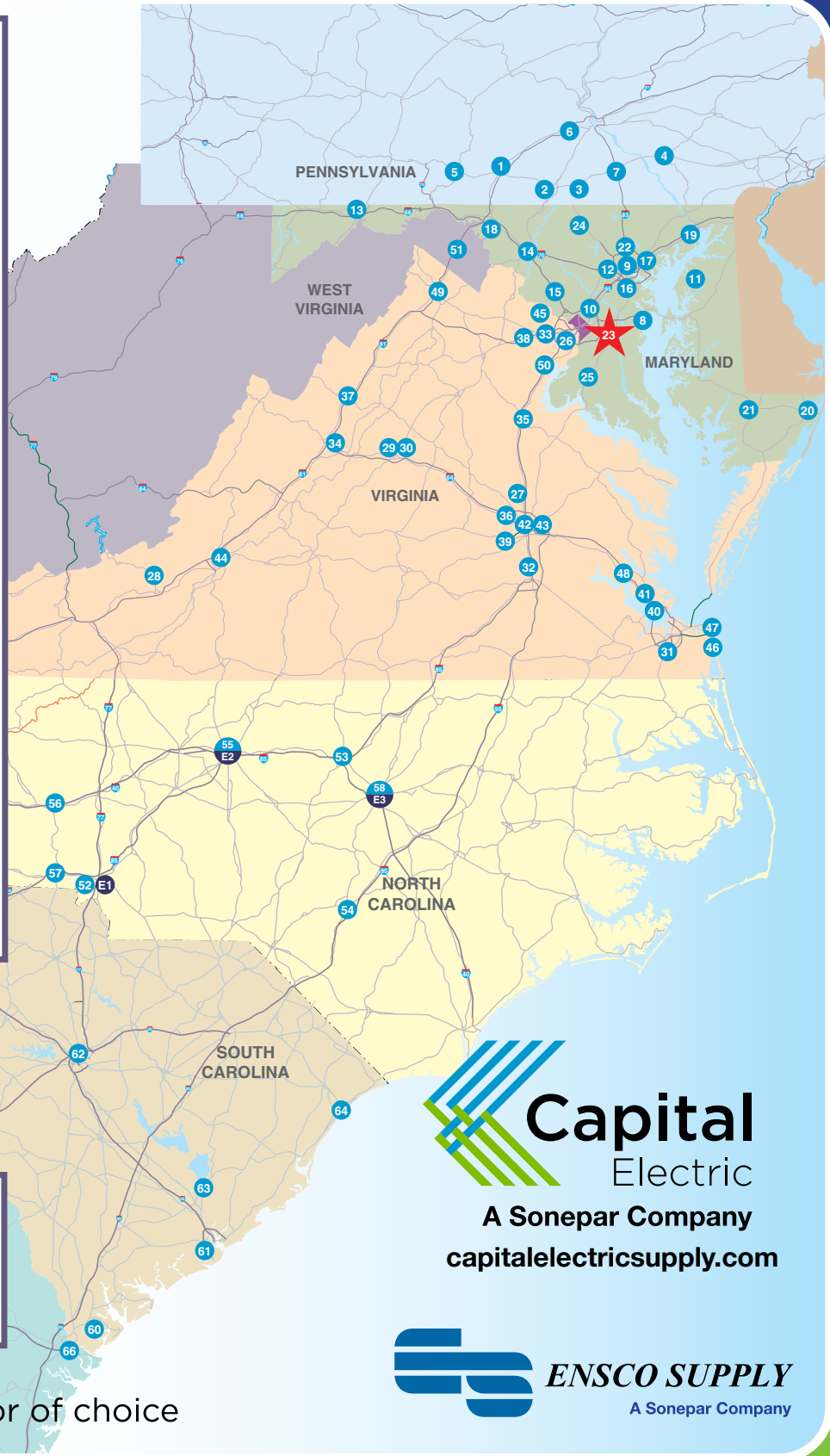

Ensko Counter Locations

North Carolina

- E1. Charlotte
- E2. Greensboro
- E3. Raleigh



Capital
Electric

A Sonepar Company

capitalelectricsupply.com



ENSCO SUPPLY

A Sonepar Company

The electrical distributor of choice



20210104

SMART BUYS

MANUFACTURER'S INDEX

Arlington	64	Kidde	1, 59-61
BRK	68, 69	Klein Tools	1, 93, 94
Broan NuTone.....	62	Kraloy.....	81
Cablofil/Legrand.....	50	Light Efficient Design.....	4, 5
Connectrac/Legrand	2, 3	Lightolier by Signify	33
Cooper Lighting Solutions	1, 13-20	Lithonia Lighting/Acuity.....	6-11
Eaton B-Line.....	12	Louisville Ladder.....	65
Eaton Bussmann	31	Lutron	34-37
Eaton Crouse-Hinds	54	Marley.....	95, 96
EiKO	38-40	Milwaukee.....	72-80
Federal Signal.....	68	Minerallac-Cully	70
Fluke.....	1,71	NaturalLED.....	50
Generac.....	55	nVent CADDY	45-49
GM Lighting	41	nVent ERICO	43, 44
Greenlee.....	89-92	Pass & Seymour/Legrand.....	56, 57
Hubbell Wiring	59	Progress Lighting.....	42
Ideal.....	66	RAB	32
ILSCO.....	82	Ridgid	87, 88
Intermatic.....	63	Schneider/Square D	51-53
iTOOLco	83-86	Sylvania	22-30
Kichler.....	41	Wiremold/Legrand	58



TM



capitalelectricsupply.com

20210211